

# Regulation 1

## Wastewater Treatment and Disposal Systems

Amended 09/20/2018, Effective 09/20/2018

### Contents

1. Purpose .....	1
2. Authority .....	1
3. Adoption by Reference .....	1
4. Definitions .....	2
5. General.....	7
6. Permits .....	9
7. Installer Certification .....	10
8. Inspection and Final Approval.....	11
9. Site Evaluations .....	12
10. Location and Design of Wastewater Treatment and Disposal Systems.....	14
11. Primary Treatment Requirements.....	16
12. Conventional Secondary Treatment.....	17
13. Alternative Treatment Systems.....	23
14. Holding Tanks, Floor Drains, Chemical Toilets, and Camping.....	24
15. Experimental Systems.....	24
16. Replacement Systems .....	25
17. Existing Use, Increased Use, and Changes to Structures or Parcel Boundaries .....	26
18. Safety and Abandonment of Wastewater Systems .....	27
19. Multi-User or Public Systems .....	28
20. Special Management Areas .....	28

**1. PURPOSE.** The purpose of this regulation is to protect public health and environmental quality from risks associated with improper disposal of wastewater within Missoula County.

**2. AUTHORITY.** Authority for this regulation is provided for in 50-2-116 MCA which requires local boards of health to adopt necessary regulations that are not less stringent than state standards for the control and disposal of wastewater from private and public buildings and facilities.

**3. ADOPTION BY REFERENCE.**

(A) For the purposes of this regulation, the following documents are incorporated by reference.

- (1) Department of Environmental Quality Circular 4, “Montana Standards for Subsurface Wastewater Treatment Systems,” 2013 edition, except for Section 1.1.4 “Deviations”.
- (2) Missoula City-County Alternative Systems Manual, 2015 edition.

(B) If there is a discrepancy between the above referenced documents and this regulation, the most stringent regulation shall be applied.

#### 4. DEFINITIONS.

(A) The following definitions apply to this regulation:

- (1) Absorption area: that area determined by multiplying the length and width of the bottom area of the disposal trench.
- (2) Absorption system: any part of a wastewater treatment and disposal system that discharges wastewater by design onto or into the ground.
- (3) Absorption trench: excavations less than or equal to three (3) feet in width where the distribution system is laid for the purpose of distributing pretreated waste effluent into the ground.
- (4) Adequate secondary treatment: secondary treatment that is similar to or better than the treatment provided by a drainfield meeting all requirements of Section 10(B) and (C). Absorption beds qualify when minimum separations are met and there is not enough room for a drainfield. Seepage pits qualify when minimum separations are met and there is not enough room for a drainfield or absorption bed. If a replacement system will not meet minimum separations, the Department can require elevated or alternative treatment systems. Adequate secondary treatment in the floodplain is an elevated sand mound or a system that incorporates advanced secondary treatment.
- (5) Advanced secondary treatment: a system designed to lower BOD and TSS to 7 day averages of 40mg/L & 45mg/L or 30 day averages of 25mg/L & 30mg/L respectively, and when necessary, also lower fecal coliform levels in wastewater effluent.
- (6) Alternative system: a wastewater treatment and disposal system approved by the Department to be used in lieu of a conventional system.
- (7) Approved site evaluator: a person approved by the Department to conduct site evaluations.
- (8) Bedrock: Material that cannot be readily excavated by hand tools, or material that does not allow water to pass through or that has insufficient quantities of fines to provide for the adequate treatment and disposal of wastewater.
- (9) Bedroom: any room that is or may be used for sleeping. An unfinished basement is considered an additional bedroom. SEE APPENDIX "F".
- (10) Camping: the temporary placement of tents or cabins, or the parking of trailers or vehicles for the purpose of sleeping. A travel trailer or RV that has skirting installed or has been connected to either electrical or sewage services in a permanent manner is not considered camping.
- (11) Certified installers: installers of wastewater treatment and disposal systems who have passed an annual examination to ensure sufficient knowledge of the sewer regulation.
- (12) Cesspool: a seepage pit without a septic tank to pre-treat the wastewater.
- (13) Community wastewater treatment and disposal system: a public wastewater treatment and disposal system which serves a non-transient population characterized by residential development.
- (14) Construction Season: March 1st through November 30th.
- (15) Containment Vault: a tank that is limited to containing accidental spills. A tank that receives wastewater from a fixture is not a containment vault.

- (16) Contaminate: an increase in the concentration of chemicals, viruses, or bacteria in water to a degree which is likely to affect present or future beneficial uses of the water or which violates any applicable ground water or surface water standard.
- (17) Conventional secondary treatment: treatment after a septic tank that consists of a drainfield, and includes systems that use infiltration chambers, gravity distribution, or pressure distribution.
- (18) DEQ: The Montana Department of Environmental Quality.
- (19) DEQ 4: The Montana Department of Environmental Quality regulatory document entitled “Montana Standards for Subsurface Wastewater Treatment Systems, 2013 Edition.”
- (20) Disposal Trench: an excavation in which the piping for an absorption system is laid for the purpose of distributing pre-treated waste effluent into the ground.
- (21) Distribution Box: a receptacle that receives septic tank effluent and distributes it equally into two (2) or more header pipes leading to the absorption area.
- (22) Dosing Tank: a water-tight receptacle placed after the septic tank or other treatment device approved by the Department, equipped with an automatic siphon or pump designed to discharge effluent.
- (23) Drain rock: the rock or coarse aggregate used in an absorption system. Drain rock does not include gravels of shale, sandstone, or limestone.
- (24) Drainageway: a course or channel along which stormwater moves in draining an area.
- (25) Dwelling or residence: one or more structures or portion thereof, which is intended, designed, or used for human occupancy and provides independent living facilities including provisions for sleeping, cooking, and sanitation.
- (26) Enlargement (of structure): an increase in the volume, or cubic feet, of a structure.
- (27) Equal Distribution: uniform distribution of septic effluent throughout an absorption system. Gravity systems with no more than ten (10) foot difference in lateral length or pressure distribution systems meet the definition of equal distribution for the purposes of this regulation.
- (28) Escarpment: any slope greater than 50 percent which extends vertically six (6) feet or more as measured from toe to top.
- (29) Experimental System: a wastewater treatment and disposal system, which is neither conventional nor alternative, which needs to be evaluated using rigorous scientific methods.
- (30) Failed Wastewater Treatment and Disposal System: a system in which the absorption system fails to accept waste at the rate of application, that no longer provides the treatment and/or disposal for which it was intended, that has a septic tank that suffers structural failure, or that violates Section 5(A) of this regulation.
- (31) Floodplain: that portion of land adjacent to a water-way which is inundated when the water-way overflows on an average frequency of once per one hundred (100) years, including all land area designated by the Federal Emergency Management Agency as being in the 100-year floodplain on the Flood Insurance Rate Maps.
- (32) Flood-prone Areas: areas where information indicates that the land is subject to flooding in a one hundred (100)-year flood event but not included on Flood Insurance Rate Maps.
- (33) Floor Drain: a drain in the floor to accept non-toilet wastewater that collects on the floor.

- (34) Gray Water: wastewater such as that which is discharged from kitchens, laundry, etc. Toilet waste is not considered gray water.
- (35) Groundwater Table: the surface of the zone of water saturation of a geologic formation. The surface of a perched water table is included in this definition.
- (36) High Seasonal Groundwater: the depth from the natural ground surface to the surface of the zone of saturation, as measured in an unlined hole or perforated monitoring well during the time of year when the water table is the highest. The term includes the surface of a perched water table.
- (37) High-Strength Waste: wastewater that has BOD5 greater than 300 mg/L, TSS greater than 150 mg/L, or fats, oils, and grease greater than 25 mg/L.
- (38) Holding tank: a watertight receptacle that receives wastewater for retention and does not, as part of its normal operation, dispose of or treat the wastewater.
- (39) Impervious layer: layer of material that has a percolation rate slower than 240 minutes per inch.
- (40) Increased Use: the enlargement or change in use of a structure that would potentially increase the effluent flow to the wastewater treatment and disposal system from the structure in excess of approved limits. Increased use includes but is not limited to the enlargement of a residence by adding one or more spaces which can be used as bedrooms. It also includes increasing a room or building's total square footage in a way that could lead to increased use in the future. The Department has the sole discretion to determine if an enlargement or change in use is an increased use.
- (41) Individual Wastewater Treatment and Disposal System: a wastewater treatment and disposal system that serves one (1) living unit or commercial unit. The term does not include a public wastewater treatment and disposal system.
- (42) Leaching Chambers: plastic (often polyolefin) chambers with an open bottom, structurally designed to carry the earth loading. The Department considers leaching chambers to be conventional systems.
- (43) Limiting layer: bedrock, an impervious layer, or seasonally high groundwater.
- (44) Living unit: the area in a dwelling or residence that is, or is designed to be, occupied by a household. For example, a duplex is considered two living units.
- (45) Lot: synonymous with "tract" or "parcel."
- (46) Mixing Zone: an area established in a permit or by a non-degradation analysis where water quality standards may be exceeded, subject to conditions imposed by the Montana Department of Environmental Quality and consistent with rules adopted by the Montana Board of Environmental Review.
- (47) Mobile Home: a transportable structure constructed without a permanent foundation.
- (48) Multi-User Wastewater Treatment and Disposal System: A wastewater treatment and disposal system that serves, or is intended to serve, more than two living or commercial units, but which is not a public wastewater treatment and disposal system. In estimating the population that will be served by a proposed residential system, the Department shall multiply the number of living units times 2.5 people per living unit.
- (49) MWTPSA: Missoula Wastewater Treatment Plant Service Area.
- (50) Natural Soil: soil that has developed through natural processes, and where no fill material has been added.

- (51) Non-Community Public Wastewater Treatment and Disposal Systems: public wastewater treatment and disposal systems which serve a transient population such as a restaurant or bar.
- (52) Non-contact cooling water: Water used for heat exchange to reduce temperature that has not come into direct contact with any waste product, raw material, intermediate or finished product.
- (53) Other components: include the unsealed portions of intermittent and recirculating sand filters, package plants and evapotranspiration systems.
- (54) Parcel: a portion of land that can be identified by legal description independent of any other portion of land.
- (55) Percolation Test: a standardized test used to determine soil permeability. This test is described in Appendix A of DEQ 4.
- (56) Permit: a written authorization issued by the Department, permitting the construction, alteration, extension, or operation of a wastewater treatment and disposal system under this regulation.
- (57) Primary Treatment: treatment provided in a septic tank containing one or more chambers.
- (58) Public Wastewater Treatment and Disposal System: a wastewater treatment and disposal system that serves 15 or more families or 25 or more persons daily for any 60 days or more in a calendar year. In estimating the population that will be served by a proposed residential system, the Department shall multiply the number of living units times 2.5 people per living unit, so that 10 or more proposed residential connections will be considered a public system.
- (59) Public Nuisance: any condition which affects an indefinite number of persons, or all the residents of a particular locality, or all persons coming within the extent of its range or operation by being injurious to health, annoying, or indecent or offensive to the senses, although the extent of the effect on individuals may vary.
- (60) Public Sewer: a government owned and operated wastewater treatment work that:
- (a) serves a community;
  - (b) is supported by full time staff and ordinances requiring connection permits and inspections by the utility; and
  - (c) consists of a community-wide collection system, a treatment plant, and a method of disposal that is subject to a DEQ discharge permit.
- (61) Replacement System: a wastewater treatment and disposal system that is installed to replace an existing system.
- (62) Running Water: A water supply that is capable of providing a continuous source of flow. Fresh water storage tanks and cisterns may qualify despite inherent limitations on water quantity.
- (63) Scarify: to break up and loosen the surface of the soil.
- (64) Sealed component: a component of wastewater treatment and disposal system that is sealed including a sewer line, sewer main, septic tank, grease trap, dosing tank, pumping chamber, holding tank, or sealed pit privy.
- (65) Sealed pit privy: an enclosed receptacle designed to receive non-water carried toilet wastes into a watertight vault for temporary storage.
- (66) Secondary Treatment: a biological wastewater treatment process occurring after solid/liquid separation in a septic tank or equivalent.
- (67) Seepage Pits: deep excavations used for the subsurface disposal of pre-treated effluent. Covered porous walled chambers are placed in the excavation and surrounded by rock.

- (68) Septic tank: a storage settling tank in which settled sludge is in immediate contact with the wastewater flowing through the tank while the organic solids are decomposed by anaerobic action.
- (69) Shared Wastewater Treatment and Disposal System: a wastewater treatment and disposal system that serves, or is intended to serve, two living units, two commercial units, or a combination of one living unit and one commercial unit. This term does not include a public wastewater treatment and disposal system.
- (70) Significant alteration: when a structure has suffered fifty (50) percent or greater destruction and is being replaced or restored. The destruction can be intentional or unintentional, resulting from things like fire, flood, or remodeling. Replacement of a mobile home with a permanent structure is considered significant alteration. Replacement of a single wide mobile home with another single wide mobile home or replacement of a double wide mobile home with another double wide mobile home with the same number of bedrooms is not significant alteration.
- (71) Single family dwelling or residence: a dwelling or residence designed to be occupied by not more than one (1) family or other group of people living in common.
- (72) Site Evaluation: an on-premises evaluation to determine if a site is suitable for the installation of a subsurface wastewater treatment and disposal system.
- (73) Slope: the rate that a ground surface declines expressed as percent of grade.
- (74) Soil Profile: a description of the soil strata using the USDA soil classification system.
- (75) Soil Texture: the amount of sand, silt or clay, measured separately in a soil mixture. (For individual definitions, see Appendix A)
- (76) Squirt Height: the height water reaches in a field test to evaluate uniform distribution in a pressure distribution system.
- (77) Steep slope: An incline with a grade of 35% or greater, and an incline with a grade between 25% and 35% for which the requirements of Section 10(B)(1)(b) of this regulation have not been satisfied.
- (78) STEP: Septic Tank Effluent Pump
- (79) STEP Septic Tank: a septic tank designed to accept pumping equipment to pump effluent into a public sewer system which meets the design criteria established by the City of Missoula Public Works division.
- (80) Structure: that which is built or constructed, an edifice or building of any kind, or any piece of work artificially built up or composed of parts joined together in some definite manner, including but not limited to: dwelling units, mobile homes, sleeping quarters, business establishments, grandstands, amphitheaters, and warehouses.
- (81) Subdivision: a division of land or land so divided that creates one or more parcels containing less than 20 acres, exclusive of public roadways, in order that the title to or possession of the parcels may be sold, rented, leased, or otherwise conveyed and includes any re-subdivision or re-write of a previous subdivision approval and any condominium or area, regardless of size, that provides permanent multiple spaces for recreational camping vehicles or mobile homes.
- (82) Surface water: any water on the earth's surface including, but not limited to streams, lakes, ponds, reservoirs, irrigation drainage systems or other water on the earth's surface. Water bodies that are part of an approved sewage treatment system and intermittent water bodies that are part of a storm drainage system are not considered surface water.

- (83) System: a Wastewater Treatment and Disposal System.
- (84) Uniform Plumbing Code: a model code developed by the International Association of Plumbing and Mechanical Officials to govern the installation and inspection of plumbing systems.
- (85) Unsealed Pit Privy: a facility designed to receive non-water carried toilet wastes into a pit excavated into natural soil.
- (86) Useable acreage: the total area of a lot minus flood plain or flood prone area.
- (87) Waste segregation: a system for the dry disposal of toilet waste by a method such as composting, chemical, dehydrating, or incinerator treatment, with a separate disposal method for gray water.
- (88) Wastewater: liquid waste which may include chemicals, household, commercial or industrial wastes, human excreta, animal and vegetable matter in suspension or solution, discharged from a dwelling, building, establishment, vehicle, or container. Gray water and non-liquid carried toilet waste are considered wastewater. Non-contact cooling water is not wastewater.
- (89) Wastewater Treatment and Disposal System: a system that receives wastewater for purposes of treatment, storage, or disposal including, but not limited to, pit privies, holding tanks, subsurface absorption systems, waterless toilets, and alternative and experimental systems. A containment vault is not a wastewater treatment and disposal system.
- (90) Zone of Saturation: that area beneath the ground in which all open spaces are filled with groundwater.

## 5. GENERAL.

### (A) Prohibited activities and exceptions.

- (1) No person may install, modify, repair, replace, use or increase the use of an on-site wastewater treatment and disposal system that may:
- contaminate any actual or potential drinking water supply;
  - cause a public health hazard as a result of access to insects, rodents, or other possible carriers of disease to humans;
  - cause a public health hazard by being accessible to persons or animals;
  - violate any law or regulation governing water pollution or wastewater treatment and disposal in effect at the time of installation;
  - pollute or contaminate state waters, in violation of 75-5-605, MCA;
  - degrade state waters unless authorized pursuant to 75-5-303, MCA;
  - cause a nuisance due to odor, unsightly appearance or other aesthetic consideration; or
  - enter directly into subsurface groundwater. A wastewater system that discharges at an elevation at or below peak seasonal groundwater is presumed to discharge directly to groundwater.
- (2) Construction, repair, alteration, or increased use to a system without primary and secondary treatment is prohibited unless permitted in accordance with these regulations.
- (3) A person may not discharge wastewater onto the ground unless it does not cause a public nuisance and meets one of the exceptions provided below:
- wastewater discharged into an approved surface application wastewater treatment and disposal system;
  - wastewater discharged onto a DEQ approved disposal site by licensed pumpers;
  - wastewater discharged from a floor drain meeting the requirements of Section 14(B);
  - wastewater discharged from a swimming pool, or spa;
  - gray water discharged from a dry structure without running water or without plumbing extended into or out of the structure; or
  - de minimis gray water discharged from camping. This does not include wastewater from an RV or any other plumbed fixture.

- (4) Unless an Underground Injection Control (UIC) permit is obtained from the U.S. Environmental Protection Agency pursuant to 40 CFR 144, a person may not install or use any sump, dry well, or wastewater treatment and disposal system for disposal of wastewater from the washing, servicing, maintenance, or storage of any vehicle, equipment or components that are associated with an internal combustion engine.
  - (5) No person may use an on-site wastewater treatment and disposal system that is located in the floodplain unless the system was installed according to the regulations effective at the time of installation. No person may increase use to a septic system in the floodplain.
  - (6) No person may use a septic system that does not have a valid permit issued by the Department if one was required at the time of construction.
  - (7) No person may dispose of high-strength waste into a wastewater absorption system.
- (B) System required.
- (1) A structure that is, or is designed to be, occupied by people must have approved toilet facilities within the structure or have uninterrupted access to approved toilet facilities within 200 feet of the structure.
  - (2) A structure with running water or with plumbing extending into or out of the structure may not be occupied unless it is connected to public sewer or an approved wastewater treatment and disposal system.
- (C) Connection to public system.
- (1) All new and replacement sewage disposal facilities must comply with the Uniform Plumbing Code requiring connection to publicly owned sewage treatment plants.
  - (2) No person owning real property with a structure that generates wastewater may install, modify, or replace a wastewater treatment and disposal system except for a gray water irrigation system when public sewer is available. Public sewer is available when a main:
    - (a) abuts or serves the property, and is within 200 feet of the structure;
    - (b) is within 200 feet of any part of the subsurface disposal system; or,
    - (c) is within 200 feet of the property line and meets all of the following:
      - (i) the owner or managing entity of the public collection and treatment system approves the connection;
      - (ii) the necessary easements are available;
      - (iii) the cost to connect is less than three times the cost of installing an on-site wastewater treatment and disposal system; and
      - (iv) it is physically practical to connect.
  - (3) If a structure on a parcel is connected to public sewer, all new structures generating wastewater on that parcel must be connected to public sewer if the owner or managing entity of the public sewer approves the connection.
  - (4) Existing wastewater treatment and disposal systems may remain in service until:
    - (a) ordered disconnected by the Health Board or other jurisdiction;
    - (b) the system fails as defined in Section 4 of this regulation;
    - (c) connection to public sewer is required; or,
    - (d) connection to public sewer is required per City of Missoula Ordinance Title 13.
  - (5) This Section (C) does not apply when the entity owning the public system refuses to allow connection or if the system has been permitted pursuant to Section 15 (Experimental Systems) of this regulation.
- (D) Circumvention.
- (1) A person may not knowingly make false statements, representations, or certifications in, or omit information from, or knowingly alter, conceal, or fail to file or maintain any notice, application, record, report, permit, plan or other document required to be filed or maintained in order to evade these regulations.
  - (2) A person may not divide a property or properties in order to evade these regulations. Examples include but are not limited to phased or piecemeal development.



## 6. PERMITS.

### (A) Permit Required.

- (1) No person may install, modify, repair, replace, or increase use of a wastewater treatment and disposal system within Missoula County without first obtaining a permit from the Department, except for activities and systems described in (A)(2) and (A)(3).
- (2) The following activities do not require a permit from the Department:
  - (a) Maintenance activities including, but not limited to, effluent filter cleaning, replacement of effluent pump(s) with an equivalent pump, removal of blockages not requiring substantial excavation of the drainfield, and pumping the septic tank.
  - (b) Investigative activities to determine location of systems, dimensions of systems, or to determine the cause of failure. A certified installer, property owner, or an authorized agent must contact the Department prior to any excavating of the absorption area.
  - (c) Surface application of wastewater from swimming pools or spas.
  - (d) Disposal of de minimis wastewater generated from camping. This does not include wastewater from RVs or any other plumbed fixture.
  - (e) Discharge of gray water from a dry structure without running water or without plumbing extended into or out of the structure.
- (3) The following systems do not require a permit from the Department:
  - (a) Sumps receiving wastewater from only water softeners, swimming pools, or spas.
  - (b) Floor drains meeting the requirement of Section 14(B) of this rule.

### (B) General Requirements for Permits.

- (1) Parcels must be recorded with the County Clerk and Recorder before a permit may be issued by the Department.
- (2) Permits must be issued in the name of the parcel's owner, but may be picked up and executed by an authorized agent.
- (3) The Department shall issue a permit following the submittal of all required fees, a complete and accurate permit application, and other necessary information demonstrating compliance with all applicable regulations. If more information is needed in order to process an application, the department shall notify the applicant.
- (4) The Department may place any other conditions on a permit, which will facilitate compliance with the provisions of this regulation or subdivision approval.
- (5) The Department may require enforceable, binding agreements which reflect representations of use made at the time of permitting. The Department may require agreements under this section to be filed at the Clerk and Recorder's office.
- (6) A permit may not be issued for a system when use of the system would constitute a violation of any ordinance, rule, law or conditional approval including but not limited to a Certificate of Subdivision Approval.
- (7) Notice of denial. Written notice that a permit has been denied must be given to the applicant. The notice must list deficiencies and reasons for the denial.
- (8) Unapproved changes. Unapproved changes in plans, specifications, or stated use after a permit has been issued or any falsification or significant error in information submitted by an applicant invalidates the permit.

### (C) Applications.

- (1) A complete application for a permit must be submitted on forms provided by the Department, be accompanied by the application fee, and include the following information:
  - (a) Name and address of applicant and owner;
  - (b) A complete legal description and physical address of the property where the wastewater treatment and disposal system is or will be located;
  - (c) A scaled site plan, showing all property boundaries, no larger than eleven (11) inches by seventeen (17) inches illustrating that the proposed site meets the minimum requirements in Sections 5(A) and 10 of this regulation;
  - (d) Floor plans of any structure to be served on paper no larger than eleven (11) inches by seventeen (17);
  - (e) A plan and relevant design specifications of the proposed wastewater treatment and disposal system; and,
  - (f) Other relevant information as required by the Department to substantiate that the proposed installation, modification, repair, replacement, or increased use complies with this regulation and applicable DEQ rules.

- (2) Applications for new or increased use must also include:
  - (a) an acceptable site evaluation as described in Section 9 or DEQ Certificate of Subdivision Approval; and,
  - (b) evidence that non-degradation requirements of ARM 17.30, Subchapters 5 & 7 have been satisfactorily addressed.
- (D) Expiration of permits and applications.
  - (1) A permit expires if the system is not installed, inspected, and approved by the Department within two (2) years of issuance.
  - (2) If a permit is not issued, an application expires one year after its submittal.
- (E) Permits are subject to the regulations in effect at the time of permit issuance.
- (F) Construction without permit. The Department shall charge a fee three (3) times the permit and application fees when the installation, repair, modification, replacement, or increased use of a system starts prior to a valid permit being issued.
- (G) Permits for Temporary Repairs or Increased Use.
  - (1) The Department may issue a temporary repair permit for a failed seepage pit, cesspool, or drainfield in areas that have received construction grants or loans, and where a government entity is actively organizing the public funding, RSID or SID necessary to install public sewer interceptor or collector systems. Temporary repairs may be accomplished by the addition of absorptive area to a currently existing system. This practice is commonly called re-rocking.
  - (2) The Department may issue a temporary permit for increased use or for the enlargement of a structure without requiring an upgrade to an existing seepage pit, cesspool, or drainfield in areas which have received construction grants or loans and where a government entity is actively organizing the public funding, RSID, or SID necessary to install public sewer systems. Such temporary increased use may be permitted by the Department only for systems which are currently accepting waste at the rate of application from the source.
  - (3) The Department shall charge a minimal administrative fee as established by the Board for a temporary repair or increased use permit. The Department is not required to inspect such repairs. Inspections must be performed by licensed installers and submitted to the Department.
    - (a) Prior to the issuance of a temporary repair permit, the owner of the property must execute any contracts, petitions, or agreements required by the utility, the Department, or other entity for the creation of SIDs or RSIDs and must meet other conditions which the municipality, the Department, or utility may require. The homeowner shall sign a document indicating that he or she will connect to public sewer within 180 days after the installation of the sewer mains designed to service the property.
  - (4) A temporary repair or increased use permit satisfies the requirements of Section 16, which establishes requirements for replacement systems.
  - (5) Applicants for temporary permits may instead apply for a normal replacement permit, using the established fees and requirements of the Department.
  - (6) The granting of a temporary permit for repair or increased use does not guarantee a life expectancy or operation of the system and if the system fails prior to availability of public sewer, further repairs or upgrades to the system may be required by the Department.

## 7. INSTALLER CERTIFICATION.

- (A) General.
  - (1) Installation, modification, replacement, or repair of a wastewater treatment and disposal system that requires a permit in accordance with Section 6 must be supervised by a person who has passed an examination administered by the Department to ensure they have sufficient knowledge and training to complete the work in compliance with this regulation.
  - (2) A certified installer must install a system according to all conditions on the permit and all applicable regulations.
  - (3) A certified installer must be on site at all times during installation.
  - (4) A certified installer must have evidence of certification at the installation site available for inspection by the Department and a copy of the appropriate permit.

- (5) The Department may not approve a system if a certified installer is not present during the installation. The Department may approve the system if a certified installer completes the system or the uncertified installer takes and passes the required certification exam(s) and the system meets all requirements.

(B) Certification and Renewal.

- (1) An installer is certified for the calendar year in which the exam was taken and passed. Certification expires annually on December 31st.
- (2) Applications for certification and certification renewal must be in writing on forms provided by the Department and must include the name, address and phone number of the applicant and the name of the business that the applicant is representing.
- (3) Applications must be accompanied by an application fee determined by the Board to defray the costs for training and exams.
- (4) Certified installers must pass an annual exam for re-certification. These exams must be submitted to the Department with the application for re-certification.

(C) Revocation of Certification.

- (1) The Department may revoke certification from an individual or from an employer and its employees for any of the following reasons:
  - (a) A single occurrence of installing or attempting to install a system without a valid permit.
  - (b) A single occurrence of deliberately falsifying an inspection.
  - (c) A single occurrence of failing to correct deficiencies noted on the inspection form.
  - (d) Repeated mistakes within a two (2) year period in installing a system in accordance with this regulation or failure to submit self-inspection forms in a timely manner. The Department must have issued a Notice of Violation within a two (2) year period prior to revoking an installer's certification for repeated installation mistakes.
- (2) Revocation of certification may extend for up to one (1) year.
- (3) When revoking a certification, the Department shall provide the installer with a written explanation of the reasons for the revocation in the form of a Notice of Violation.

## 8. INSPECTION & FINAL APPROVAL.

- (A) All systems must receive final approval from the Department for a permit to remain valid.
- (B) Wastewater treatment and disposal systems require an inspection prior to covering the system unless specific permission has been granted by the Department to backfill a portion of the system for a justified reason.
- (C) When there is no certified installer on site during an inspection the Department may charge a reinspection fee to return and reinspect the system when a certified installer is on site. The Department may waive the requirement to have a certified installer on site during an inspection by arrangements made prior to the inspection.
- (D) When final approval is withheld, a written notice of deficiencies and required corrective action must be given to the certified installer or property owner. The certified installer or property owner must notify the Department upon correction of all deficiencies. The Department shall confirm the deficiencies have been corrected prior to granting final approval. If reinspection is required the Department shall charge a re-inspection fee established by the Board.
- (E) When final approval is granted by the Department, but a deficiency requiring correction exists, the Certified Installer must correct the deficiency. The Department may require that the Certified Installer provide evidence that the deficiency has been corrected.
- (F) The applicant or installer must notify the Department not less than one business day prior to a system being ready for a final inspection.
- (G) Certified installers, after receiving permission from the Department, may inspect their own installations and certify the system is installed in compliance with these regulations on forms provided by the Department when Department personnel are unable to inspect the system within one (1) business day of the requested inspection time. The installer

must submit a completed inspection of the system, including a drawing and location of the disposal system, to the Department within two (2) business days after receiving permission to self-inspect.

- (H) When a signed copy of the 'as built' plans for an engineered system is required by DEQ 4, Appendix D, the owner or authorized agent must submit the plans as described in DEQ 4 to the Department within 90 business days following the final inspection.
- (I) Acceptance of a permit by the applicant confers upon the Department the authority to access the installation site at reasonable times to inspect or to collect samples. The Department may also inspect existing systems that have been subject to complaint(s), create health hazard(s), or have become public nuisances.
- (J) Deviations from the approved plans, which do not violate the regulation, may be approved by the Department. Approved deviations must be noted on the inspection form.

## 9. SITE EVALUATIONS.

- (A) A site evaluation must be conducted by an approved site evaluator who has passed an examination administered by the Department to demonstrate knowledge of soils and site characteristics and how they relate to the design and function of wastewater treatment and disposal systems. The following persons may be approved site evaluators.
  - (1) Professional Engineers specializing in civil, environmental, sanitary, or agricultural engineering;
  - (2) Persons possessing a B.S. degree in geology, hydrogeology, or soils science;
  - (3) Registered Sanitarians with sufficient soils course work or specialized soils training; or,
  - (4) Other persons with equivalent expertise or experience, as determined by the Department.
- (B) A person taking the test to become an approved site evaluator must pay a fee as determined by the Board.
- (C) A site evaluation must be conducted in the location of each proposed system. The following factors must be evaluated: size and shape of the lot, soil conditions, slope of natural and finished grade, depth to groundwater, proximity to existing and proposed water supplies, proximity to existing systems, proximity to surface water, floodplain and flood prone areas, escarpments, and area available for the system and its designated replacement area.
- (D) Soil conditions. Where the Department determines adequate soils information is not available, soil conditions must be obtained by digging two (2) pits, one to a depth of at least ten (10) feet and a second to a depth of at least five (5) feet, located at each end of the proposed absorption system site.
- (E) The U.S. Department of Agriculture's "Soils Classification System" must be used to describe and determine soil texture. (see DEQ 4 Appendix B). The following factors must be included in any soils evaluation:
  - (1) Thickness of layers or horizons of soil profile.
  - (2) Texture and structure of horizons.
  - (3) General color, and color variation (mottling).
  - (4) Depth to water (if observed) or a statement that groundwater depth exceeds six feet throughout the entire year based on evidence from pits, borings, or other physical substantiation.
  - (5) Depth to bedrock or impervious layer (if observed).
  - (6) Other prominent features that would have a bearing on a site's compatibility for use as a wastewater absorption site. Additional soils information may be required.
  - (7) The site of the soil testing must be clearly identified by placing a perforated pipe to a depth of nine (9) feet in the soil profile hole.
- (F) The Department may require as many soil profile holes be dug in the area of the proposed absorption system as the Department determines is necessary to describe and evaluate the soils of the site.
- (G) A person performing a site evaluation on a parcel shall submit to the Department all data and locations on all test holes and percolation tests performed on the parcel.

- (H) When a site evaluation is required, the evaluation may be performed by an approved site evaluator or the applicant may request that the Department perform the site evaluation.
  - (1) If a site evaluation is not conducted by the Department, the Department may require access to the property where the proposed site is located to confirm information submitted by the applicant. The Department may reject a site evaluation if access is denied.
  - (2) The Department may refuse to accept site evaluations from persons who have a documented history of supplying inaccurate site evaluations or incomplete information as required.
  
- (I) Percolation Tests and Exceptions.
  - (1) A percolation test is required in accordance with Table 1.
  - (2) If a potential impervious layer is present less than six (6) feet below ground level, percolation tests must be conducted in this layer unless other testing (e.g. hydrometer, permeameter, or other approved hydraulic conductivity test) is provided that substantiate the layer is not impervious.
  - (3) Three percolation tests must be conducted, when required, in accordance with DEQ 4, Appendix A on absorption system sites. Test holes must be evenly spaced throughout the area of the proposed absorption site.
  - (4) Percolation tests must be conducted by an Approved Site Evaluator.

**TABLE 1**

<b>Soil Type</b>	<b>Percolation Testing Required?</b>
Any extremely gravelly, cobbly, or bouldery soil	YES, Unless sand-lining and pressure distribution is provided
Coarse sand Sand Loamy sand	YES, Unless sand-lining and pressure distribution is provided
Medium sand Fine sandy loam Fine sand Very fine sand Sandy loam Loam Non-compacted silt loam	NO
Compacted silt loam Sandy clay loam Clay loam Silty clay loam Sandy clay Silty clay Silt Clay	YES

## 10. LOCATION AND DESIGN OF WASTEWATER TREATMENT AND DISPOSAL SYSTEMS.

### (A) General.

- (1) All systems must be located and designed in accordance with DEQ 4 unless a more specific or stringent requirement is included in this Code.
- (2) Applicants proposing a new wastewater treatment and disposal system, or increased use of a system must designate a full sized separate replacement area that meets all the criteria for the initial drainfield or absorption system without any sizing reductions.
- (3) The Department may require that both the primary and replacement drainfield areas be identified by staking prior to construction.
- (4) All individual wastewater systems and designated replacement areas being reviewed as part of a Sanitation in Subdivision application must be located on the same lot as the dwelling or business served. This provision does not apply to:
  - (a) wastewater systems or replacement areas proposed on lots created on or before December 31, 2009; or,
  - (b) wastewater systems or replacement areas proposed on lots created as part of any Sanitation in Subdivision application submitted to the Department by December 31, 2009; or,
  - (c) wastewater systems or replacement areas proposed on lots created as part of any subdivisions with preliminary plat approvals from the County Commissioners or City Council by December 31, 2009; or,
  - (d) wastewater systems and replacement areas located off of the lot prior to application for subdivision.
- (5) A structure, movable or immovable, may not be located over, or moved onto, any part of the system. Vehicles may not be driven over the system after installation, except those portions properly designed to accept traffic loads. The drainfield or other absorption system must be located and protected in a manner that prevents vehicles from passing over or parking on top of the system. This area must be kept free of all obstructions, including pavement, which will prevent air from penetrating the soil.
- (6) Fill may not be used to overcome minimum vertical or horizontal separation distances in Sections 10(B) and (C), except for sealed components.

### (B) Prohibited locations.

- (1) Steep slopes.
  - (a) No system or any portion of a system may be located on a slope that exceeds 35%.
  - (b) Systems may not be located on slopes between 15% and 35% unless a registered professional engineer or a person qualified to evaluate and identify soil in accordance with the Natural Resource Conservation Service standards submits adequate evidence that conditions are such that there will be no visible outflow of effluent down slope from the installation of the system.
  - (c) Systems must meet minimum setback distances from steep slopes in accordance with Table 2.
- (2) Floodplain or flood-prone areas.
  - (a) Absorption systems may not be located within 100 feet of a floodplain or flood-prone area.
  - (b) When property within the designated FEMA floodplain can be shown to be above base floodplain elevation, an official action from FEMA is required to remove the area from the floodplain before a permit may be issued by the Department. If the property is within shaded Zone X floodplain, written approval from the Floodplain Administrator is sufficient.
  - (c) A parcel containing Zone A approximate floodplain must have the base flood elevation determined by a licensed professional engineer through hydrologic and hydraulic analysis, or another method approved by the Floodplain Administrator before the Department may:
    - (i) approve a subdivision or,
    - (ii) issue a septic permit on a DEQ-reviewed parcel that was created after August 15, 1983.
- (3) Waterways. A subsurface treatment and disposal system may not be located within a drainage way or within a natural or manmade intermittent watercourse.
- (4) Groundwater. Groundwater depth at any time of less than six (6) feet from the natural ground surface precludes the use of conventional subsurface wastewater treatment and disposal systems. There must be a minimum separation of at least four (4) feet of natural soil between the bottom of the drainfield and the maximum high groundwater elevation.
  - (a) The Department may require one (1) year of groundwater monitoring conducted by the Department to delineate the highest groundwater level.
  - (b) If the groundwater is within ten (10) feet of the ground surface, or if there is any reason to believe

that the groundwater will be within ten 10 feet of the natural ground surface during any time of the year, groundwater monitoring is required.

- (c) The applicant must provide groundwater test holes and piping to a depth of at least nine (9) feet within the boundary of the proposed drainfield to determine the high groundwater during its peak occurrence. If shallow groundwater or an impervious layer is encountered during excavation of the test holes at a depth less than nine (9) feet, the piping may be placed at that depth.
  - (d) The Department may refuse to accept seasonal high groundwater data when total precipitation for the previous year (defined as May 1 of the previous year through April 30 of the current year), or April 1 snowpack water equivalent, measured at the nearest officially recognized monitoring station, is more than 20 percent below the historical average.
  - (e) The Department may consider soil morphology data and data from nearby groundwater monitoring sites with similar soil, geology and proximity to streams or irrigation ditches, if available, to determine maximum groundwater elevation. Morphology data may only be substituted if groundwater monitoring was conducted and precipitation or snowpack for the monitoring period is more than 20 percent below the historical average per Section 10(B)(3)(d). The Department may charge a fee to be determined by the Board for review of morphology data.
- (5) Bedrock and impervious layers. Four (4) feet of natural soil must be present between the bottom of the absorption system and bedrock or an impervious layer throughout the proposed drainfield site and replacement area.

(C) Minimum horizontal setbacks.

Minimum horizontal setbacks are shown in Table 2, with clarifying statements shown in 1-8 below.

**TABLE 2**  
**Minimum Horizontal Setback Distances in Feet**

FROM:	TO:		
	Sealed components	Other components	Absorption systems
Public or multi-user wells/springs	100	100	100
Other wells	50	50	100
Property Boundaries	10	10	10
Foundation Walls	10	10	10
Suction lines	50	50	100
Cisterns	25	25	50
Irrigation Ditches (8)	50	50	100
Roadcuts, escarpments (2)	10	10	25
Floodplain or flood prone area (3)(4)(5)	-	100	100
Steep slopes (1)(2)	10	10	25
Subsurface drains	10	10	10
Water Lines(6)	10	10	10
Drainfields/sand mounds	10	10	-
Surface water, springs	50	50	100

- (1) Sewer lines and sewer mains may be located in roadways and on steep slopes if the lines and mains are safeguarded against damage.
- (2) The minimum horizontal setback from a slope or escarpment applies to the slope down gradient of the absorption system.
- (3) Sealed transport lines may be located within the flood prone/floodplain area.
- (4) If the floodplain has not been designated and its level relative to a wastewater system is in question, the applicant must submit evidence adequate to establish the location of the floodplain.
- (5) Sealed components of a wastewater system located in a 100-year floodplain or area of high groundwater must be designed and constructed to prevent surface and ground water inundation. Pump lines must be pressure tested prior to use and must have a pressure rating of at least two (2) times the operating pressure or pump shutoff pressure, whichever is greater. Pipes must be tested at 1.5 times the operating pressure or pump shutoff pressure,

whichever is greater, or must be tested as specified by the manufacturer.

- (6) Separation of Water and Sewer
  - (a) Horizontal separation of at least ten (10) feet is required between sewer and water mains, unless the sewer main must cross the water line. The distance shall be measured from the closest edge of each pipe.
  - (b) Sewer mains which must cross water mains shall be laid to provide a minimum distance of 18 inches between the outside of the pipes. Service lines shall be constructed in accordance with the Uniform Plumbing Code.
- (7) The Department may require greater horizontal separation distances than those specified in Table 2 if it determines that site conditions or water quality non-degradation requirements indicate a need for the greater distance.
- (8) Exceptions for Irrigation Ditches.
  - (a) The setback distance from an irrigation ditch to an absorption system may be reduced to a minimum of 50 feet provided the ditch is sealed prior to construction of the system to prevent seepage of water out of the ditch and seepage of wastewater into the ditch. The setback distances may be reduced to a minimum of 10 feet based on a case by case evaluation of engineered plans for piping submitted to the department.
  - (b) If the top of the absorption system is to be placed at an elevation equal to or lower than the flow line of the ditch to prevent wastewater effluent from entering the ditch and groundwater monitoring during the peak season demonstrates that seepage of water from the ditch will not result in a depth to groundwater of less than six (6) feet in the area of the absorption system, the setback distance may be reduced to a minimum of 50 feet.

**(D) Maximum land application rates.**

- (1) Wastewater application into the soil may not exceed 700 gallons/useable acre/day for any system or group of systems.
  - (a) Total area for the purpose of calculating the maximum land application rate may include lots, interior parks, and public right of ways within the subdivision, minus floodplain or flood-prone area.
  - (b) All parcels included within a proposed project may be considered to determine compliance with this section.
  - (c) For the purpose of calculating application rate limits each individual single family dwelling unit is considered to have a discharge of 350 gallons per day. The application rate for multi-family units will be calculated using the flows shown in Table 4.
  - (d) Flow rates for industrial and non-residential establishments must be as determined by design in accordance with DEQ 4, Chapter 3.
- (2) Exceptions:
  - (a) Existing lots not being reviewed for subdivision to be used for single family dwelling(s) or multi-family dwellings with 4 or fewer dwelling units do not have to meet the requirements of 10(D)(1), but must demonstrate adequate room for both a drainfield and full replacement area and meet all other requirements of these regulations.
  - (b) If a Level II wastewater treatment system is used and nitrate is projected to be 5 mg/l or less at the end of the mixing zone, wastewater application may increase to 1,400 gallons/useable acres/day.
  - (c) If a DEQ groundwater discharge permit restricts and requires monitoring of the nitrate level in the effluent, wastewater application may increase based on the following formula:

$$(50 \text{ mg/l} \div x \text{ mg/l}) \times 700 \text{ gallons/useable acre/day, where } x \text{ is the discharge permit nitrate limit in mg/l}$$

## **11. PRIMARY TREATMENT REQUIREMENTS.**

- (A) All new and replacement wastewater treatment and disposal systems must provide a primary treatment device prior to disposal in an absorption system.
- (B) The primary treatment device must consist of a septic tank that conforms to the design and construction requirements in DEQ 4.
- (C) Septic tanks must be leak tested in accordance with DEQ 4 and as required by this section.
  - (1) A tank that is, or may be, in groundwater must be leak tested in place, except an individual or shared tank with a design flow of less than 700 gallons per day may submit a certificate from the tank manufacturer stating that the tank was leak tested before transport to the site.
  - (2) The Department may require a tank to be leak tested following installation if there is evidence that the tank or seals have been damaged and may no longer be water tight.



- (D) Septic tanks must be located where they are readily accessible for inspection and maintenance. Nothing may be constructed or installed over a septic or dosing tank that would prevent the tank access openings from being readily accessible.
- (E) Septic tanks must be sized in accordance with DEQ-4, Chapter 5.
- (F) The pipe between the structure and the septic tank may not have a single bend of more than 45°.
- (G) Access and inspection ports must be provided as required in DEQ 4, and must extend to the ground surface.
- (H) All access ports 22 inches or larger in diameter must be equipped with a safety pan or basket device.
- (I) Covers on all access and inspection ports must remain in place and be secured per manufacturer’s specifications unless the tank or filter is being serviced.
- (J) The septic tank must be set on undisturbed ground or properly bedded with sand to prevent settling of the tank. The tank must be installed level.
- (K) Septic tank outlets must include an effluent filter with an opening no larger than 1/8 inch or another approved device such as a screened pump vault.

**12. CONVENTIONAL SECONDARY TREATMENT.**

- (A) Drainfield wastewater flow rates.
  - (1) Design wastewater flow for residential use shall be as follows:
    - (a) A living unit on an individual wastewater treatment and disposal system must be sized using the design flow in Table 3;
    - (b) If 2 or more living units use a common absorption system the wastewater treatment and disposal system must be sized using the design flow in Table 4;
    - (c) When 10 or more living units use a common absorption system, the design flow may be reduced to 250 gpd per living unit. The Department may determine that a larger per-living-unit average design flow is necessary for a given project.
    - (d) Design flow is based on individual living units, not collective number of bedrooms.
    - (e) The Department will use the guidelines established in Appendix F to determine if a room is to be considered a bedroom for determining minimum design flow rates.

**TABLE 3**  
**Minimum Design Flow Rates for Residential Individual Systems**

1 bedroom	300 gpd
2 bedrooms	300 gpd
3 bedrooms	300 gpd
4 bedrooms	350 gpd
5 bedrooms	400 gpd
Each additional bedroom	add 50 gpd

**TABLE 4**  
**Minimum Design Flow Rates for Residential Shared and Multi-user Systems**

<b><u>First Living Unit</u></b>			<b><u>Subsequent Living Units</u></b>	
1 bedroom	300 gpd		1 bedroom	150 gpd
2 bedrooms	300 gpd		2 bedrooms	225 gpd
3 bedrooms	300 gpd	+	3 bedrooms	300 gpd
4 bedrooms	350 gpd		4 bedrooms	350 gpd
5 bedrooms	400 gpd		5 bedrooms	400 gpd
Each additional bedroom	- add 50 gpd		Each additional bedroom	- add 50 gpd

- (2) Wastewater flow rates for non-residential, industrial, recreational, and commercial establishments are determined by:
  - (a) DEQ 4, Chapter 3; or
  - (b) Applicable tables and charts found in the EPA Design Manual for Onsite Wastewater Treatment and Disposal Systems; or
  - (c) Metered flow data which has been approved by the Department gathered from comparable facilities.

(B) Drainfield application rates.

- (1) Application rates for residential and non-residential drainfields are determined using Table 5.
- (2) The most conservative of soils profile report or percolation rate will be used to select applicable square footage.
- (3) The following formula must be used to determine the size in lineal feet of the drainfield. Example calculations can be found in Appendix A.

$$\text{Lineal feet} = \frac{\text{gallons of effluent per day}}{\text{application rate} \times \text{width of trench in feet}}$$

**TABLE 5**

<b>Texture</b>	<b>Est. Perc rate (min/in)</b>	<b>App. Rate (gpd/ft<sup>2</sup>)</b>
Gravelly to extremely gravelly sands, extremely gravelly loamy sands, coarse sands and coarser soils	< 3	0.8
Loamy sand, coarse & gravelly sands & gravelly loamy sands from above that perc 3 – 6 mpi	3 - < 6	0.8
Medium sand, sandy loam	6 - <10	0.6
Fine sandy loam, fine sand, loam	10 - <16	0.5
Very fine sand, Sandy clay loam, silt loam	16 - <31	0.4
Clay loam, silty clay loam	31 - <51	0.3
Sandy clay	51 - <121	0.2
Clays, silts, silty clays	121 - ≤240	0.15
Any soils that perc >240 minutes per inch (this is considered an impervious layer, and a system that relies on absorption is not permitted)	>240	Not Permitted

(C) Pressure Distribution.

- (1) Pressure distribution and sand lining in accordance with DEQ 4 is required if the percolation rate is less than three (3) minutes per inch.
- (2) Pressure distribution is required for the following:
  - (a) If the soil is coarse or loamy sand and there is less than six (6) feet between the bottom of the absorption trench and a limiting layer.
  - (b) If more than 1000 square feet of absorption area is needed prior to the application of any reductions in sizing.
  - (c) If any portion of the absorption system lies on a slope greater than 25 percent.
  - (d) If an effluent pump is part of the system design.
  - (e) Shallow Drainfields, Elevated Sand Mounds, Absorption Beds, and Deep Absorption Trench systems.
  - (f) Replacement systems that cannot meet all separations in Section 10(B) & (C) of this regulation.
  - (g) Replacement drainfields installed in fill.
  - (h) Trenches greater than 24 inches wide when leaching chambers are used.
- (3) Pressure distribution may also be required in other alternative or experimental systems.

(D) Drainfield construction details.

- (1) Drainfield construction details must conform to the standards found in Table 6 and below:
  - (a) Drain rock around drainfield pipes must be clean, with no more than 2 percent passing the No. 8 sieve.
  - (b) Drain rock must be covered with a minimum of two (2) layers of untreated building paper, synthetic drainage fabric or other approved material before backfill. Straw may not be used in place of building paper or drainage fabric.
  - (c) For gravity fed systems, the pipe connecting the septic tank and the drainfield must be properly bedded and consist of schedule 40 PVC pipe at least three inches in diameter and lie on a slope of not less than 1/8 inch/ft.
  - (d) Pipe used in gravity flow drainfields shall be perforated PVC pipe at least four (4) inches in diameter.
  - (e) Header pipes shall consist of solid class 200 or Schedule 40 PVC pipe.
  - (f) The ends of drainfield laterals must be marked with a metal location marker.
  - (g) Perforations in drainfield pipe shall be placed at five (5) and seven (7) o'clock.
  - (h) Perforated pipe connecting the ends of the drainfield laterals will not be included when calculating absorption area sizing.
  - (i) When trenches have been excavated, the sides and bottom must be raked to scarify any smeared soil surfaces. Construction equipment not needed to construct the system must be kept off the absorption area to prevent soil compaction. Construction must not be initiated when the soil moisture content is high.
  - (j) Equal distribution of septic tank effluent throughout the secondary treatment system is required.
  - (k) Minor leveling is allowed in accordance with DEQ 4.
  
- (2) Distribution Boxes. When gravity-fed drainfield laterals are installed at different elevations, a dosing distribution box is required, and:
  - (a) The total length of perforated pipe of each connection to a distribution box may not vary by more than 10 feet;
  - (b) The bottom of all outlets of the distribution box must be level, and the bottom of the inlet must be at least one (1) inch above the outlets;
  - (c) The distribution box must be adequately bedded to prevent settling;
  - (d) The location of the distribution box must be marked by a metal location marker to facilitate locating the distribution box for maintenance and inspection;
  - (e) At least five (5) feet of solid pipe must extend from a distribution box; and
  - (f) The certified installer must test the distribution box at the time of inspection by filling it with water to ensure equal distribution.

**TABLE 6**

	Units	Gravity Maximum	Gravity Minimum	Pressure Maximum	Pressure Minimum
Trench length	feet	100	0	-	0
Trench width	inches	24	18	36	12
Trench depth	inches	36	24	36	24
Slope of drainfield lines	percent	0	0	0	0
Slope of trench bottom	percent	0	0	0	0
Slope of header pipe	percent	0	0	0	0
Depth of drain rock:	inches				
Under pipe		-	6	-	6
Over pipe		-	2	-	2
Size of drain rock	inches	2.5	.75	2.5	.75
Space between centers	feet	-	7	-	7

- (3) Leaching Chambers. Figure 1 shows a typical cross section of a leaching chamber installed with pressure distribution.

**FIGURE 1  
CUTAWAY OF A TYPICAL LEACHING CHAMBER SYSTEM**

**METHOD A  
TOP PLACEMENT**

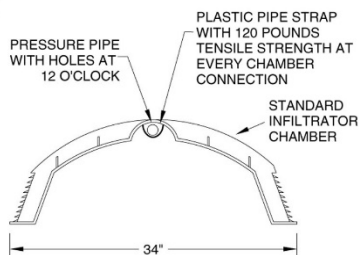

**METHOD B  
BOTTOM PLACEMENT**

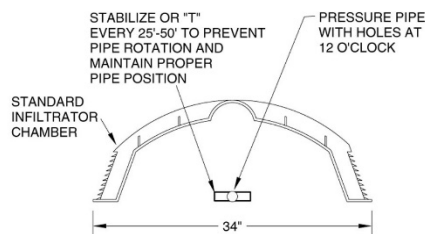

- (a) Leaching chambers may be used, and must be installed in accordance with DEQ 4.
- (b) The required absorption system size may be reduced by 25 percent if using leaching chambers. Systems using leaching chambers must maintain a replacement area large enough to accommodate a system without chambers.
- (c) Leaching chambers must have at least 12 inches of cover and be compacted by foot compression along the sides of the chamber to provide support for the chambers.
- (d) In clay soils, the space between the louvers of chamber systems and the trench sidewall must be filled with loam or sandy soil.
- (e) For installations with pressure distribution, the following requirements apply:
- (i) For installations with pipe hung in the top of the chamber (see Figure 1) the pipes must be secured with plastic strap with a minimum 120 pounds of tensile strength.
  - (ii) For installations with pipe placed directly on the trench bottom (see Figure 1) stabilizing T's must be installed every 25 to 50 feet to prevent pipe rotation and maintain orifice position. Stabilizing T's are only required when the lateral is more than 50 feet long.
  - (iii) Orifices must be placed at the 12 o'clock position, except orifices at each end of the lateral, and one orifice every 25 feet along the lateral must be faced down and have an orifice shield placed under them to allow for drainage of the pipe.
  - (iv) Access for pipe maintenance and flushing and a metal pipe cap or other metal location marker must be provided at the end of each lateral.
- (E) Pressure Distribution Secondary Treatment.
- (1) When pressure distribution is used, a three (3) foot trench width with four (4) foot separation between trench edges is allowed.
  - (2) A pump or siphon may be used to provide pressure distribution. A typical layout for a pressure distribution system is depicted in Figure 2.
  - (3) The distribution system must be designed by an engineer or someone experienced in the design of pressure distribution systems to ensure equal distribution and minimum squirt height throughout the drainfield.
  - (4) Dosing tanks must have access ports sufficiently large to maintain the tank and pumps, and must be vented. Pumps, valves and other apparatus, which require maintenance, must be accessible from the surface without entering the tank or be located in a dry tank adjacent to the wet chamber. Pumps and controls must be corrosion resistant and meet National Electrical Code requirements.
  - (5) The dose volume must be equal to the drained volume of the discharge pipe and manifold plus a volume between five (5) and ten (10) times the distribution pipe volume. If a programmable timer is used, the minimum dose size may be equal to two (2) times the distribution pipe volume.

- (6) Dosing pumps and siphons used for pressure distribution systems must be selected to provide a minimum of five (5) feet of head for orifices 5/32 inch or smaller, and 2.3 feet of head for orifices 3/16" or larger.
- (7) All lateral and manifold piping shall be Schedule 40 or stronger PVC pipe. The pipe must have a single row of perforations 1/8 inch diameter or larger in a straight line perpendicular to the ground surface. Maximum perforation spacing is five (5) feet. An equivalent design that assures uniform distribution and minimum squirt height may be provided with the approval of the reviewing authority.
- (8) A hydraulic analysis demonstrating uniform distribution and minimum required squirt height must be provided. The analysis must show no greater than ten (10) percent variation in distribution of dose across the entire drainfield.
- (9) Distribution pipes of pressure-distributed drainfields must have capped inspection risers that terminate no more than six (6) inches below ground surface. Inspection risers must be installed with a long-sweep elbow or single 45° bend. A metal location marker must be provided for each inspection riser.
- (10) Pressure distribution systems and controls must be field tested to demonstrate uniform flow distribution prior to approval of the system. The system must be tested by pressurizing it with water before covering the distribution pipe with gravel. Holes must be facing up for this test. The elevation of the spray from each hole must be a minimum of five (5) feet for orifices 5/32 inch or smaller, and 2.3 feet for orifices 3/16" or larger and maintain a maximum flow variance of 10 percent.
- (11) Dosing tanks, except those designed in accordance with the City of Missoula's Standard Installation Manual for Residential On-Site STEP System Sanitary Sewer Connection, must comply with the following requirements unless the Department approves alterations that have been justified by a Professional Engineer.
  - (a) The dosing tank must have adequate volume to provide storage for the necessary effluent dose, the transport line (if the line drains back) and the required reserve capacity.
  - (b) The reserve volume must be equal to at least 25 percent of the daily flow.
  - (c) Dosing tanks must be made of reinforced concrete meeting the same structural standards as those required for septic tanks in DEQ Circular 4 or an approved equivalent.
  - (d) Risers for pump access must be a minimum of 18 inch inside diameter and must be constructed of concrete, ribbed fiberglass or other approved non-corrosive durable material. The pump access must extend to finished grade and have a secure cover made of concrete or fiberglass.
  - (e) Pump vaults must be installed to allow for venting back through the septic tank. A vent with an activated carbon filter is recommended and is required if an odor nuisance is created.
- (12) Pumps must comply with the following requirements:
  - (a) Pumps used for pressure distribution systems must meet the specifications determined by the pressure distribution design criteria.
  - (b) Pumping head must be within the manufacturer's recommended operating range for that pump. Pumping head is determined using the elevation distance between the lowest pumping level in the dosing tank and the highest level in the drainfield system and adding the total of the friction losses for the transport pipe and any fittings.
  - (c) Pumps must be designed and approved for intended use.
  - (d) The effluent must be screened through a 1/8 inch filter before it enters the pump chamber.
  - (e) Pumps must be installed to be easily removed without entering the access port. Pumps must be provided with an easy, readily available means of electrical and plumbing disconnect, and a non-corrosive lifting device as a means of removal for servicing.
  - (f) Pump systems must be designed to keep the pump motor submerged unless an explosion proof pump is installed that is acceptable for use in a hazardous environment in accordance with the National Electric Code ANSI/NFPA 70.
  - (g) Every new or replacement system requiring a pump must have a properly functioning audible and visible high water alarm installed in the pump chamber with a manual silencing switch located in or near the building served by the system. An electrical safety switch must be installed near this alarm. The alarm must be installed on a separate circuit from the pump. The electrical and alarm systems must be installed in accordance with the National Electric Code and other applicable rules.
- (13) Transport pipes must comply with the following requirements:
  - (a) All pressure transport pipe and fittings must meet or exceed ASTM Specification D-2241. Polyvinyl chloride (PVC) transport pipes must be at least Schedule 40 or Class 200 PVC. Polyethylene (PE) transport pipe of one (1) inch or less must have a minimum pressure rating of 200 pounds per square inch (psi). For diameters greater than one (1) inch, the minimum pressure shall be 160 psi.

- (b) Continuously pressurized transport lines (systems with check valves) must be buried a minimum of 60 inches deep unless the line is insulated with two (2) inches of high density styrofoam insulation capable of providing a thermal resistance of 10.8 at 40°F mean temperature. Insulated lines may not be shallower than 24 inches. This requirement includes any portion of a pressurized line that is shallower than 60 inches. Transport lines designed to flow back after each dose must be buried at least two (2) feet deep.
  - (c) An isolation valve must be placed on a continuously pressurized transport pipe in or near the dosing tank to allow for repairs without flowback of sewage.
  - (d) Transport pipes must be installed to prevent siphoning of the drainfield back into the tank or the tank effluent into the drainfield. This may be accomplished using weep holes or anti-siphon valves.
- (F) Siphons must comply with the following requirements:
- (1) The specifications for the siphon including elevation difference between the tank and drainfield, and slope profile of the site must be submitted to the Department for review and approval for use in the specific application proposed.
  - (2) Siphons must use a minimum four (4) inch diameter external vent line which vents back to the dosing chamber.
  - (3) Siphons must be constructed of corrosion-resistant materials and installed according to manufacturer's recommendation.
  - (4) Effluent screens or filters with an outlet no larger than 1/8 inch must be installed to protect the siphon snifter tube from plugging.
  - (5) The owner of a system that uses a siphon is responsible for ensuring the ongoing proper operation of the siphon.
  - (6) All systems using siphons must be field tested prior to approval of the system. Pressure distribution systems using siphons must use orifices at least 5/32 inches in diameter and be tested by pressurizing the system with water before covering the distribution pipe. The squirt height must be a minimum of five (5) feet and maintain a flow variance of 10 percent or less.
  - (7) Systems using a siphon should have a dose counter installed to check for continued function of the siphon.

**FIGURE 2  
PRESSURE DISTRIBUTION NETWORK**

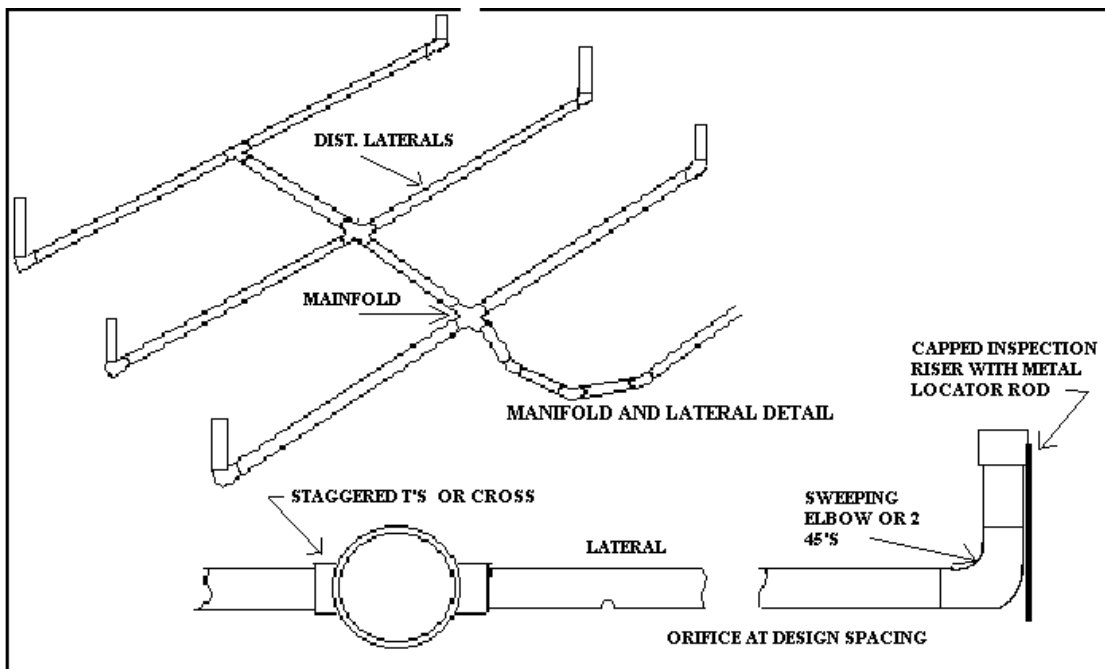

**FIGURE 3  
COMBINATION SEPTIC TANK / PUMP VAULT**

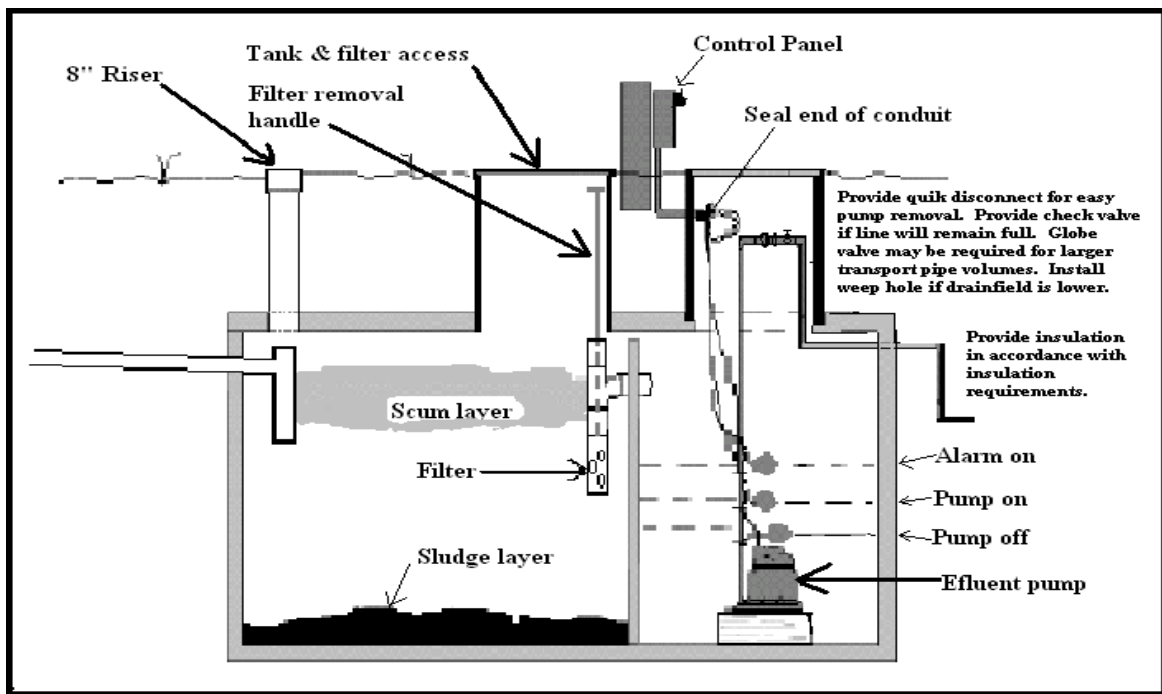

### 13. ALTERNATIVE TREATMENT SYSTEMS.

- (A) Alternative wastewater systems may be approved by the Department to be used in lieu of conventional systems. Alternative treatment systems must meet the requirements prescribed in the Missoula City-County Alternative Systems Manual.
- (B) The applicant shall provide substantial scientific field testing information concerning a particular system design for systems not in the Alternative Systems Manual before the system may be approved as an alternative. The information must indicate that the system will perform for the purpose for which it is designed over a period of years with proper maintenance.
- (C) Unless the Alternative Systems Manual provides otherwise, all rules pertaining to conventional drainfields and septic tanks apply to alternative systems.
- (D) Alternative systems may require additional inspections during and after installation and an additional inspection fee may be charged for each inspection. The Department must provide a written report of each inspection to the system owner listing deficiencies of the system and corrections needed for the system.
- (E) Use of an alternative system may preclude future divisions of the property pursuant to DEQ requirements. The applicant and future owners assume responsibility for any restrictions, liabilities or encumbrances that are caused by the installation and use of an alternative system.
- (F) All alternative system designs, with the exception of pit privies, must provide for replacement areas equivalent to those required for conventional systems in the event of system failure.

- (G) The Department may place any restrictions or requirements on the design, installation and operation of an alternative system that it deems necessary. Such restrictions or requirements include but are not limited to: temporary or ongoing monitoring, discharge limitations on pollutants, and provisions to ensure proper maintenance and operation of alternative systems. In such cases the Department shall be allowed access to the property to verify that such restrictions or requirements are implemented. Failure to properly follow permit restrictions or conditions, or failure to properly maintain an alternative system is a violation of this rule and grounds for permit revocation.
- (H) Design criteria for the alternative systems approved for use by the Department are available at the Environmental Health Division Office and on the Department's website.

#### **14. HOLDING TANKS, FLOOR DRAINS, CHEMICAL TOILETS, AND CAMPING.**

- (A) Holding tanks are not allowed.
- (B) Floor Drains.
- (1) Floor drains may be used in areas used for parking or storing vehicles, equipment, or components that are associated with an internal combustion engine under the following conditions:
    - (a) The structure may not house a business that washes, works on, repairs or rebuilds vehicles, equipment or components that are associated with an internal combustion engine;
    - (b) Floor drains may only be used to convey snow melt and rainwater from a structure;
    - (c) No deleterious substances may be disposed of in the floor drain;
    - (d) The floor drain may not accept wastewater from a plumbed fixture; and,
    - (e) The drain line extending from the floor drain:
      - (i) may not cause wastewater to travel onto neighboring property;
      - (ii) must dispose of the wastewater on the same parcel as the structure is located;
      - (iii) must dispose of the wastewater at least 10 feet from property lines and at least 100 feet from wells and surface water;
      - (iv) must dispose of the wastewater above ground onto pervious soil;
      - (v) may not discharge into a sump or injection well; and,
      - (vi) must dispose of the wastewater in a location that can be easily located and routinely observed by the structure's occupants.
- (C) Chemical Toilets. Chemical toilets may be used for temporary events, construction sites and at other locations where a permanent system is not required. Chemical toilets may not be used to serve as a permanent sewer system for structures, except chemical toilets may be used as the approved toilet facilities for picnic shelters in parks owned or operated by the city or county.
- (D) Camping. The Department may require the submittal of a waste disposal plan meeting the requirements of these regulations when a tent, RV, camper, or other temporary structure is placed for the purpose of camping in one area for 30 or more days outside of a licensed campground or RV park.

#### **15. EXPERIMENTAL SYSTEMS.**

- (A) A wastewater treatment and disposal system not specifically allowed under this regulation may receive a permit as an experimental system. Experimental permits are intended for the primary purpose of conducting an experiment, and may not substitute for a variance from this regulation.
- (B) Experimental systems may only be permitted under the following conditions:
- (1) The applicant must provide adequate information to the Department that ensures the system will effectively treat wastewater in a manner that will prevent groundwater contamination and will meet all of the requirements in Section 5(A) at all times. Failure to meet the requirements of Section 5(A) or any permit conditions at any time shall invalidate the permit and be grounds to order cessation of use of the system and buildings that the system serves.
  - (2) The application must include a complete description of the scientific goals of the project and criteria used to evaluate the performance of the system. The evaluation process and requirements must be detailed in a contract or other written agreement between the evaluating entity and system owner, if different.



- (3) The experiment must be conducted by a scientific, educational, governmental, or engineering organization.
  - (4) The applicant must provide any funding necessary for adequate design, installation, monitoring, and maintenance.
  - (5) The system must be designed by a Professional Engineer, sanitarian or other professional acceptable to the Department.
- (C) A permit to construct an experimental system is not transferable from person to person.
- (D) The Department may refuse to issue a permit for an experimental system for any reason.
- (E) The Department may limit the number of experimental permits issued in a year.
- (F) The Department may place any requirements or restriction it deems necessary on a permit for an experimental system.
- (G) All provisions of Health Department regulations apply to experimental systems except those specifically exempted by the permit.
- (H) Applicants must provide for inspections to be made by persons approved by the Department. A performance and evaluation report must be submitted annually to the Department for the duration of the experiment.
- (I) There must be the potential to connect to public sewer, or an adequate replacement area for a conventional wastewater treatment and disposal system without sizing reductions must be designated and preserved if the experimental system is connected to an occupied structure.
- (J) Systems required to connect to a publicly owned sewage treatment plant under Section 5(C) of this regulation, but not connected as a provision of an experimental permit may be required to connect once the experiment ends or the permit is no longer valid.
- (K) Any person who sells a property containing an experimental system must disclose all permit, monitoring and maintenance requirements to the buyer. In the case of a transfer of ownership of the property, the designated experimenter must remain the same.
- (L) An experimental system may be re-classified by the Department as an alternative system after submission of a final performance report demonstrating sufficient evidence has been collected to show that the system meets the performance and evaluation criteria of the permit and functions satisfactorily over time.
- (M) By March 1<sup>st</sup> of the calendar year the permit holder of an experimental permit must pay an annual review fee as established by the Board.

## **16. REPLACEMENT SYSTEMS.**

- (A) A person may not operate a wastewater treatment and disposal system that has failed, as defined in Section 4 of this regulation. Failed systems must be replaced and meet the following requirements:
- (1) Replacement systems must be designed and constructed to allow the best treatment practical and must meet all separation distances whenever possible.
    - (a) A drainfield is required when there is adequate room;
    - (b) If room is unavailable for a drainfield, an absorption bed is required;
    - (c) If room is unavailable for either a drainfield or absorption bed, a seepage pit may be allowed where groundwater is a minimum of 25 feet below the bottom of the proposed seepage pit.
  - (2) If a replacement system will not meet minimum separations in Sections 10(B) & (C), a pressure distribution system is required.
  - (3) Replacement systems will be sized based on the previously approved number of bedrooms or flow limitations unless the increased use requirements of Section 17 are met.

- (B) Seepage pits may be permitted under the following conditions for replacement systems regardless of the area available in areas that are expected to receive public sewer service within five (5) years, as determined by the Department. Seepage Pits permitted under this section must also comply with the Alternative Systems Manual, Section 21.
- (1) Seepage pit replacement permits will expire 180 days after public sewer becomes available to the property as described in Section 5(C);
  - (2) The property owner must execute a deed restriction waiving the right to protest an SID or RSID for the installation of public sewer; and,
  - (3) Upon expiration of a permit issued under this section, all structures served by the permitted wastewater treatment and disposal system must be connected to public sewer.
- (C) A wastewater treatment and disposal system originally approved for use with 1,000 gallons septic tank capacity and legally installed before May 20, 2004 may replace the absorption area without increasing septic tank capacity if serving four (4) or less bedrooms. If the tank has not been pumped of its contents within the 12 months preceding permit issuance, it must be pumped prior to final inspection.
- (D) Soil profiles and percolation tests may be required to determine proper sizing of replacement systems.
- (E) Replacement of systems in floodplain.
- (1) A system in a floodplain or flood-prone area that was legally installed must be replaced with an elevated sand mound or a system that incorporates advanced secondary treatment. The bottom of the trench or drainfield must be above floodplain elevation, or the system must include advanced secondary treatment before wastewater is discharged into the soil.
  - (2) Replacement sealed pump chambers must be designed to prevent floating in a flood.
  - (3) A system that was not legally installed must be replaced with a system that is in full compliance with this Code.
- (F) Drainfields in Fill.
- (1) Drainfields may only be installed in fill for the replacement of failing systems or as part of an alternative system approved by the Department.
  - (2) Drainfields in fill must be designed, constructed, and located in accordance with DEQ 4.
  - (3) Minor leveling is allowed for replacement systems in accordance with DEQ 4.
  - (4) Fill may not be considered natural soil.
  - (5) Fill may not be used to overcome minimum separation requirements in Section 10(B) and (C) of this regulation.

## **17. EXISTING USE, INCREASED USE, AND CHANGES TO STRUCTURES OR PARCEL BOUNDARIES.**

- (A) Existing use and connection to existing systems.
- (1) The continued use or maintenance of a properly functioning existing wastewater treatment system legally installed according to regulations and standards in effect at the time of construction is allowed unless the system causes a violation of Section 5(A) of this regulation or is ordered disconnected by the Health Board or other jurisdiction. Such a system may not be enlarged, repaired, subject to increased use, or altered in any manner unless the alteration(s) bring the system into compliance with current regulations.
  - (2) No person may connect to a wastewater treatment and disposal system when the system or connection point (in the case of a multiple connection system) has been unused or disconnected from any residence or structure for more than one (1) year without a written septic determination issued by the Department verifying that the system meets the requirements of Section 5(A) of this regulation; has primary and secondary treatment; and meets the separation requirements in Section 10(B) & (C) of this regulation.
- (B) Increased use, new use, and altering parcel lines.
- (1) No person may increase use to an existing system or operate an existing system that has increased use unless the system meets all current requirements of this regulation or a temporary increased use permit is granted pursuant to Section 6(G).

- (2) A properly functioning system originally permitted for three (3) bedrooms with a 1,000 gallon septic tank legally installed before May 20, 2004 may increase use to four (4) bedrooms without increasing septic tank capacity. The tank must be pumped of its contents prior to final approval, unless evidence is provided that it has been pumped of its contents within the twelve months preceding permit issuance. The drainfield may have to be modified to accept the increased use.
- (3) To increase use to an existing system in the MWTPSA, a person must file a waiver of protest as described in Section 20(A)(1) of this rule.
- (4) Adding new or increased use or structures to a parcel, or changing parcel boundaries, may not encroach upon or eliminate replacement areas for existing use.
- (5) No person may install, cause to install or operate additional wastewater systems on a parcel of land or subdivide a parcel of land with a cesspool or other system that does not meet the requirements of Section 5(A) of this regulation. Substandard systems must be upgraded to meet Section 5(A), provide primary and secondary treatment, meet all separation requirements in Section 10(B) & (C), and reserve a full replacement area that meets current requirements of this regulation.

(C) Significant Alteration and Enlargement of Structure.

- (1) The following conditions apply to enlargement and significant alteration of structures:
  - (a) No person may begin construction until the Department issues either a septic permit or a written determination that no septic permit is needed for the proposed project;
  - (b) No person may build over any portion of a system except the pipe from the structure to the septic tank;
  - (c) An adequate replacement area must be preserved that is at least equivalent to what was available before the proposed enlargement or significant alteration;
  - (d) The system must provide primary and adequate secondary treatment;
  - (e) The system must meet Section 5(A)(1) of this regulation; and,
  - (f) If public sewer is available as described in Section 5(C), the applicant shall connect to public sewer.

(D) Septic Determinations.

- (1) A complete application for a determination must be submitted on forms provided by the Department and must include the following:
  - (a) Applicant name and mailing address
  - (b) Property owner name and mailing address
  - (c) Address and legal description of property
  - (d) A brief description of proposed project
  - (e) A site plan, on paper no larger than 11" x 17", accurately showing all existing and proposed buildings, wells, septic systems, replacement areas, surface water and floodplains or flood prone areas on or within 100 feet of the property
  - (f) Detailed floor plans, on paper no larger than 11" x 17", showing the existing floor plan and the floor plan of the proposed project
  - (g) Other relevant information as required by the Department to clearly define the scope of the project and to ascertain compliance with this Code
  - (i) Septic determination application fee
- (2) Unapproved changes in plans or specifications after a determination is issued or any falsification or significant error in information submitted by an applicant invalidates the determination.
- (3) The Department may place conditions in a determination regarding future use of the enlarged structure to facilitate compliance with the provisions of this regulation.

## 18. SAFETY AND ABANDONMENT OF WASTEWATER SYSTEMS.

- (A) When a wastewater treatment and disposal system is replaced, or will no longer be used, the system shall be considered abandoned and any further use of the system for any purpose is prohibited.
- (B) When a septic tank, seepage pit, or cesspool is abandoned it must be:
  - (1) located;
  - (2) pumped entirely of its contents by a licensed septage hauler; and,

- (3) properly abandoned in one of the following ways:
  - (a) filled with sand, gravel, or other suitable material;
  - (b) broken into pieces with the resultant hole being filled with suitable material; or
  - (c) removed, with the resultant hole being filled with suitable material.

## 19. MULTI-USER OR PUBLIC SYSTEMS.

- (A) Plans for public and multi-user wastewater treatment and disposal systems must be approved by DEQ and permitted by the Department.
- (B) Applicants for a multi-user or public wastewater treatment and disposal system shall submit a maintenance and operation plan to the Department in accordance with DEQ 4, designating who is responsible for maintenance and operation of the system. Maintenance and operation must be carried out according to the approved plans.
- (C) All portions of the multi-user or public system, except for on-lot service lines and individual tanks, must be installed before the system may be used. In the case of a phased subdivision, the treatment system installed must be adequate to serve a particular phase before the system is put into use.
- (D) An individual connection to a multi-user or public system requires a permit before installation. The connection must have final approval by the Department prior to use. An individual connection to a community system must also be inspected by the certified operator or the design engineer for the system.
- (E) A multi-user or public wastewater treatment and disposal system must be installed on a separate utility lot, in a common area, in an easement, or on the same lot as all the structures served so that it can easily and legally be accessed by the system's users for maintenance and repair of the system.

## 20. SPECIAL MANAGEMENT AREAS.

- (A) Missoula Wastewater Treatment Plant Service Area (MWTPSA). The purpose of the MWTPSA requirements are to place landowners on notice that permission to use wastewater disposal in this area is temporary and is intended to be replaced with discharge to a public sewage treatment plant. The following restrictions apply to all land within the Missoula Wastewater Treatment Plant Service Area depicted on the map in Appendix D:
  - (1) The Department may not issue a permit for an increased use, a new wastewater treatment and disposal system, or a replacement seepage pit in the MWTPSA unless the owner(s) execute a deed restriction waiving the right to protest the creation of a Special Improvement District (SID) or a Rural Special Improvement District (RSID) for the installation of public sewer, using the language set forth below.

*"I/We, the undersigned, hereby certify that I/we are the owners of the real property located at (legal description) which is in an area where public sewer is planned to be installed. I/we hereby waive any right to protest an RSIDs or SIDs affecting said property for the purpose of financing the design and construction of a public sewer benefiting said property. Further, my/our signatures on this waiver may be used in lieu of my/our signature(s) on an RSID or SID petition for the creation of one or more RSID or SID petitions for the purpose of financing the design and construction of a public sewer benefiting the above-described property. This deed restriction is granted by the current and future owners of the property to the County or City of Missoula in exchange for permission to discharge sewage into the ground until such time that public sewer is installed.*

*This deed restriction shall also constitute an agreement whereby the owner(s) must connect to public sewer within 180 days after public sewer mains are installed and available to the property.*

*This waiver runs with the land and shall be binding on the transferees, successors, and assigns of the owners of the land described herein. All documents of conveyance must refer to and incorporate this waiver."*

- The filing of a deed restriction is not required if previously filed for the same parcel, or where similar language has been shown on an approved and filed subdivision plat or certificate of survey.
- (2) Owners of property encumbered by a deed restriction must connect to sewer as established in the deed restriction.
  - (3) A new division of land, including any subdivision as defined in Section 4 within the MWTPSA must exhibit language consistent with Section 20(A)(1) of this regulation on the face of the recorded plat or on a Certificate of Survey. Language approved by the City and County Attorney is available at the Department.
  - (4) Any person installing a new or replacement septic tank in an area of the MWTPSA designated for STEP (shown in Appendix D) must install a STEP septic tank with manway.
  - (5) A Multi-user or community wastewater treatment and disposal system serving five or more connections in the MWTPSA must be designed and located to allow a single, common future connection point to public sewer, and must conform to the design criteria established by the City of Missoula Public Works Department. The design, installation and inspection of all mains, service lines to public sewer, STEP tanks, and related appurtenances must be approved by the City of Missoula Public Works Department in accordance with its design criteria for sewers. As-built plans for all multi-user, community, or dry laid systems must be submitted to the City of Missoula Public Works Department and the Department by the applicant within 90 days of installation.
  - (6) A new subdivision-within the MWTPSA must provide easements as necessary to facilitate the connection of all parcels requiring facilities to public sewer service when sewer mains become available.
  - (7) If a property in the MWTPSA is part of a proposed subdivision containing five (5) or more lots of less than two (2) acres per lot in all phases, the developer must provide a multi-user or community wastewater treatment and disposal system converging at one common point that may be easily connected to public sewer when sewer mains are available to service the property.
  - (8) A properly designed, installed and inspected dry laid pressure or gravity main connecting the lots with appropriate easements may be used in place of a multi-user or community system as required above in areas where the subdivision contains no more than fourteen 14 lots in all phases approved after September 21st, 1994 when the City Engineer makes the following written findings provided to the Department:
    - (a) That the design of the dry-laid system meets City Public Works criteria for design of sewers; and,
    - (b) that a dry laid main is preferable in a given instance to a community or multi-family septic system for eventual connection to public sewer because:
      - (i) the dry laid system will be less expensive for future homeowners to connect to public sewer; or
      - (ii) because site characteristics make it infeasible to connect a community or multi family system to public sewer in the future.
  - (9) When the subdivision includes perpetually dedicated common areas and wildlands or an area reserved from development by deed restriction until public sewer becomes available, the Department will divide the area of such dedicated land by the number of lots and add the result to each lot area to determine applicability of Section 20(A)(7).
- (B) Rattlesnake Valley Special Management Area. The following restrictions apply to wastewater treatment and disposal systems in the portion of the Rattlesnake Creek Drainage above the Mountain Water intake dam classified as A-closed by DEQ (see Appendix E).
- (1) A wastewater treatment and disposal system serving one (1) single family dwelling or other use with flows less than or equal to a single family dwelling per lot or parcel will be allowed provided all other requirements are met.
  - (2) Except for a boundary line relocation, the Department may not issue a permit or approve a Certificate of Subdivision Approval for subsurface disposal of wastewater for a new division or subdivision of land inside the special management area.
  - (3) The Department may place any conditions on a wastewater treatment and disposal system permit it deems necessary to ensure compliance with the A-closed classification standards, including but not limited to requiring an alternative treatment system effective at removing pathogens.
- (C) Roman Creek/Touchette Lane Special-Management Area. The following restrictions shall apply to all land included within the E 1/2 of Section 29, W 1/2 of Section 27, Section 28, T15N, R21W, bordered on the north by the Frenchtown Irrigation Canal and bordered on the south by U.S. Interstate 90.

- (1) All parcels with existing plat approvals may install systems if the site meets the four (4) foot separation required from the bottom of the disposal trench to high seasonal groundwater. High groundwater testing may be required to satisfy this requirement.
  - (2) All parcels without existing plat approvals may only install one single family system if all other requirements of this regulation are met.
  - (3) The Department shall perform a preliminary inspection of the site with the excavator at the start of construction to ensure that:
    - (a) maximum depth is maintained; and
    - (b) the absorption system is located properly.
  - (4) Wells must be grouted to a minimum twenty (20) feet. Bacterial samples are recommended and disinfection may be necessary to ensure a potable water supply. A copy of the well log shall be submitted to the Department showing adequate compliance with the plat approval and Montana DNRC Well Drilling Requirements.
  - (5) The Department may not approve further subdivisions which create lots that generate wastewater or require wastewater facilities in the area until the cause of water contamination is discovered and the problem corrected.
- (D) Seeley Lake Special Management Area. The following restrictions apply to land located in the NW quarter of T16 R15 Section 2, the East half of T16 R15 S03, and the South half of T17 R15 S35 (see Appendix G).
- (1) New or increased use may not be approved unless the Department determines that it will not cause or contribute to a violation of the nitrate standard established in 76-5-605, MCA.
  - (2) The Department will evaluate septic permit applications on a case by case basis, using the best information available including, but not limited to, nitrate sample results and existing studies on groundwater flow direction. The Department may require an applicant to supply additional information to substantiate that groundwater will be protected.
  - (3) Provided there has been no unapproved increased use, replacement systems will be allowed in this area.
- (E) Non-designated Areas of Concern.  
The Department may impose restrictions or conditions on new, increased use or replacement wastewater treatment and disposal permits in areas where the activities may cause or contribute to the violation of water quality standards established in Title 75, Chapter 5, MCA.

## Appendix A: Sample Calculations of Absorption System Sizing

The following general examples illustrate how conventional absorption system sizing is typically calculated. Note: There are sizing/design requirements not specifically addressed in these examples. These examples are provided for illustrative purposes only.

**Example 1:** An applicant proposes a drainfield downhill of a new 4-bedroom home in “gravelly silt loam” soils. The system may use gravity distribution (if topography allows). Sizing of the absorption system is calculated as follows:

$$\frac{350 \text{ gallons per day design flow}}{.4 \text{ application rate X 2 foot trench width}} = \begin{matrix} 438 \text{ LINEAL FEET WITHOUT CHAMBERS} \\ \text{OR} \\ 328 \text{ LINEAL FEET WITH CHAMBERS (25\% sizing reduction)} \end{matrix}$$

---

**Example #2:** An applicant proposes a drainfield downhill of a new 3-bedroom home in “very-gravelly sandy clay” soils. Percolation testing shows a perc rate averaging 30 minutes per inch at the proposed drainfield site. In this example, the absorption area would be sized based on the soil type of “sandy clay” because this is the more conservative value. The system must use pressure distribution because the absorption area will be greater than 1,000 square feet. Sizing of this absorption system is calculated as follows:

$$\frac{300 \text{ gallons per day design flow}}{.2 \text{ application rate X 3 foot trench width}} = \begin{matrix} 500 \text{ LINEAL FEET WITHOUT CHAMBERS} \\ \text{OR} \\ 375 \text{ LINEAL FEET WITH CHAMBERS (25\% sizing reduction)} \end{matrix}$$

---

**Example #3:** An applicant proposes a drainfield downhill of a new 5-bedroom home in “extremely-gravelly sandy loam” soils. Unless percolation testing shows that the soil perc rates are slower than 3 minutes per inch, the trenches must be lined with medium sand and use pressure distribution because the soil is extremely gravelly. Sizing of this absorption system is calculated as follows:

$$\frac{400 \text{ gallons per day design flow}}{.6 \text{ application rate X 3 foot trench width}} = \begin{matrix} 222 \text{ LINEAL FEET WITHOUT CHAMBERS} \\ \text{OR} \\ 167 \text{ LINEAL FEET WITH CHAMBERS (25\% sizing reduction)} \end{matrix}$$



---

**Example #4:** An applicant proposes a drainfield downhill of a new 3-bedroom home in “gravelly sandy clay loam” soils. Percolation testing shows a perc rate averaging 50 minutes per inch at the proposed drainfield site. In this example, the absorption area would be sized based on the percolation rates because this is the more conservative value. The system may use gravity distribution (if topography allows) because the absorption area is not more than 1,000 square feet. Sizing of this absorption system is calculated as follows:

$$\frac{300 \text{ gallons per day design flow}}{.3 \text{ application rate X 2 foot trench width}} = \begin{matrix} 500 \text{ LINEAL FEET WITHOUT CHAMBERS} \\ \text{OR} \\ 375 \text{ LINEAL FEET WITH CHAMBERS (25\% sizing reduction)} \end{matrix}$$

### Appendix B Absorption System Construction Detail Minimum Separation Distances Illustration

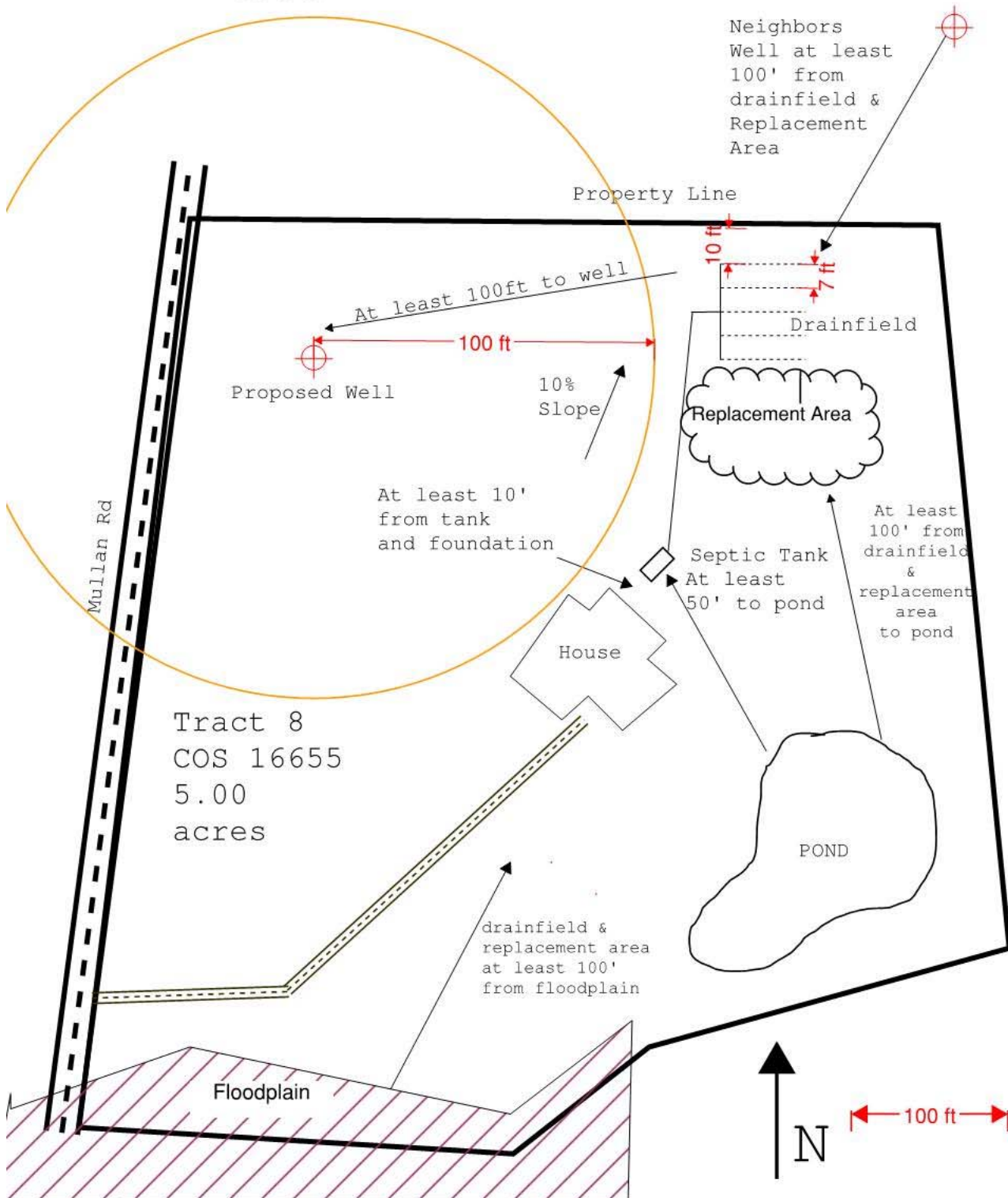
Joe Smith New Residence  
Address  
Geocode





Appendix B Absorption system Construction Detail (continued)  
Disposal Field Layout

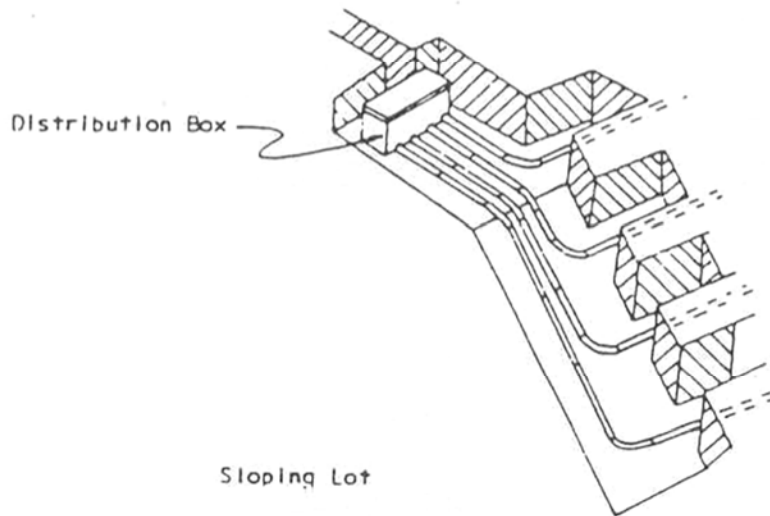
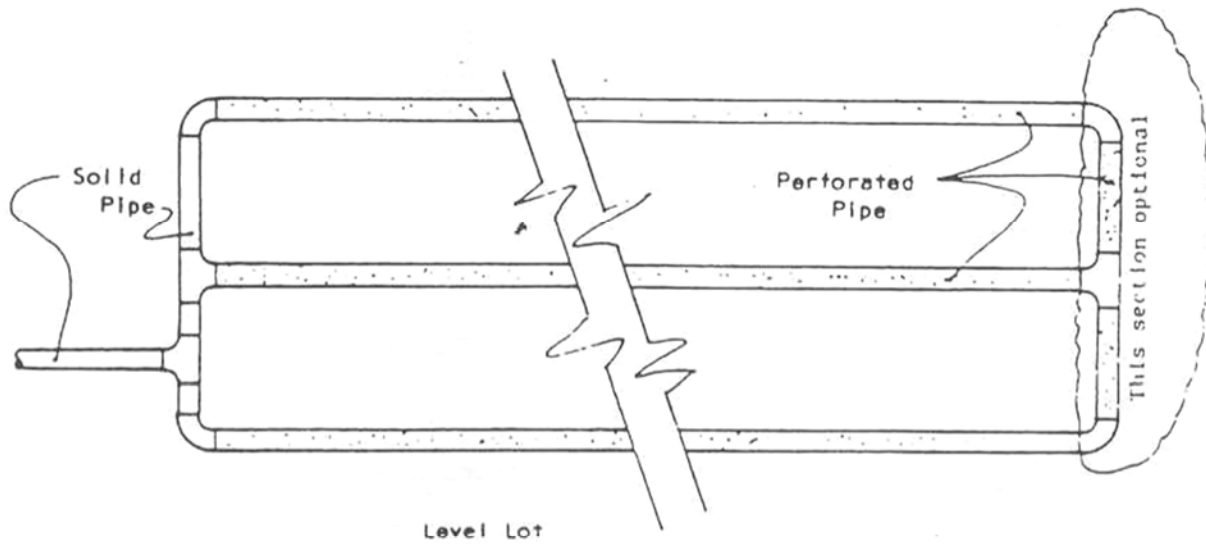

Appendix B Absorption system Construction Detail (continued)  
Absorption trench Detail

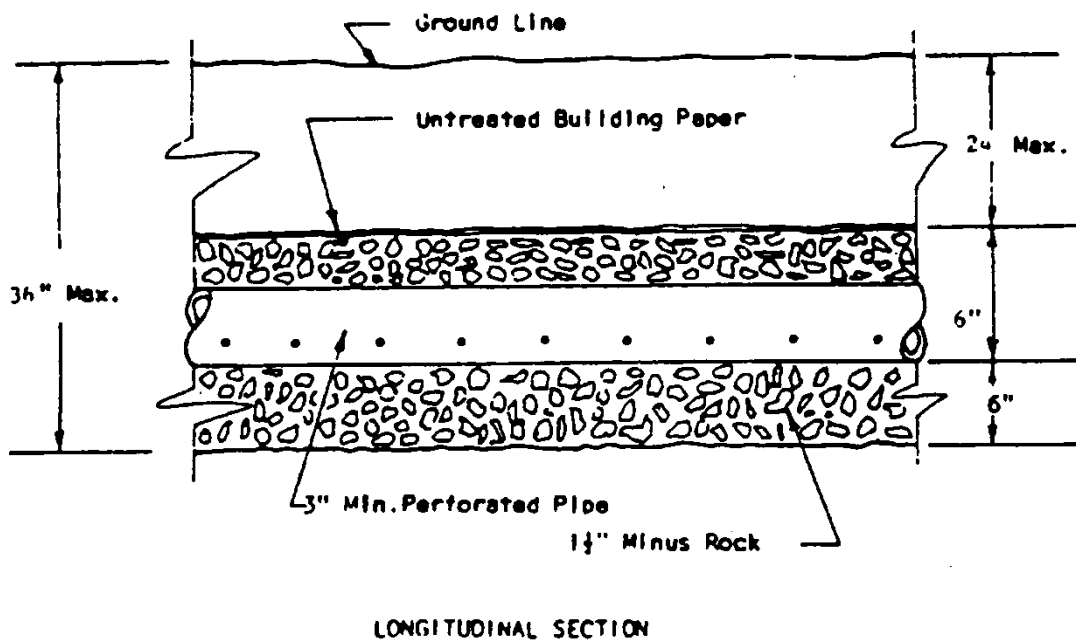
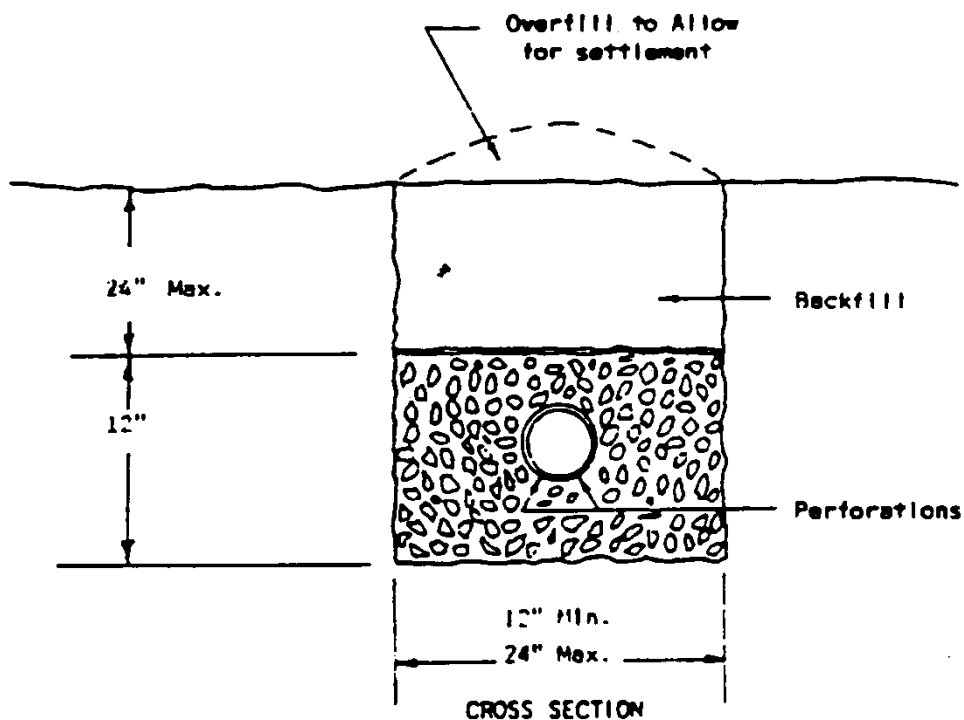

Appendix B Absorption system Construction Detail (continued)

**ABSORPTION BED**

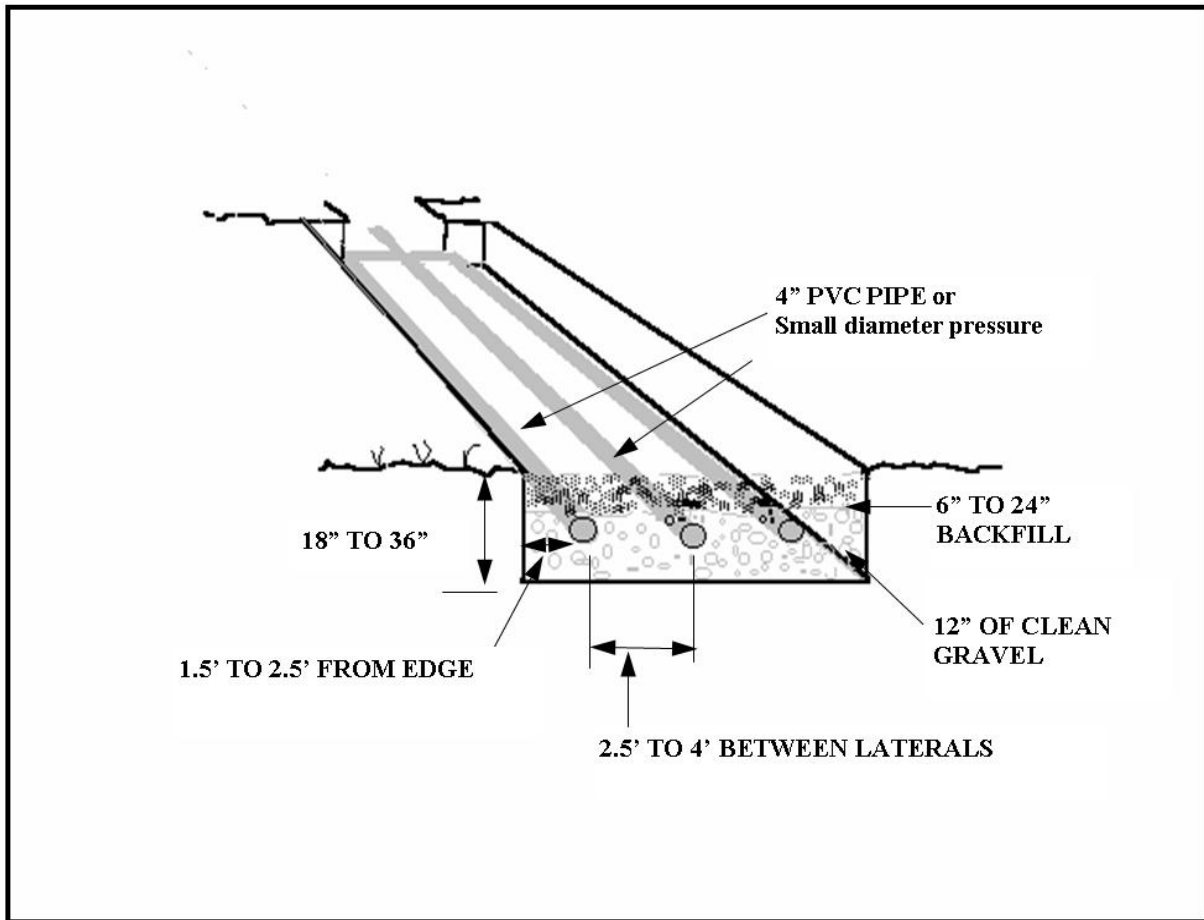

Appendix C: Dosing Distribution Box Operation Detail

**Dosing Distribution Box**

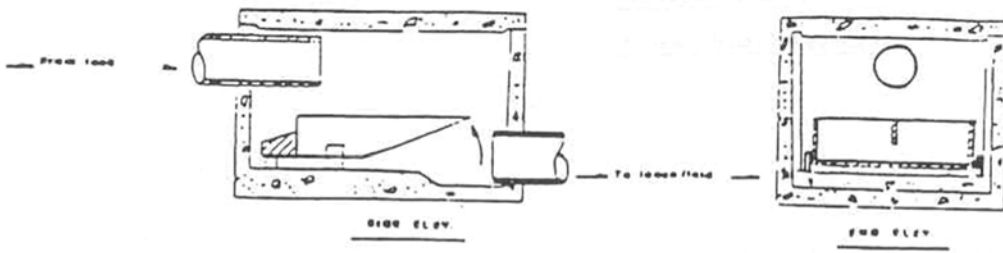

FIG. 2 Flap from tank closed.

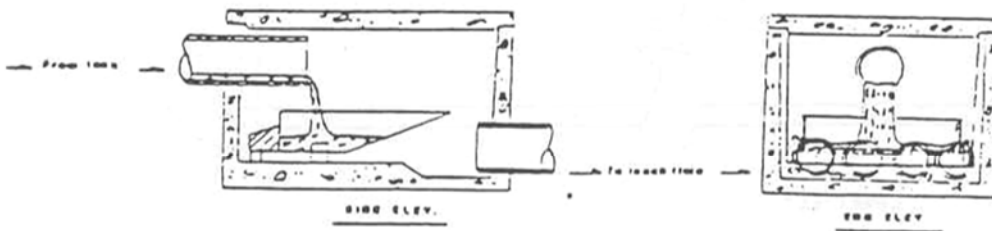

FIG. 3 "DIPPER" approximates volume of 1.3 gallons.

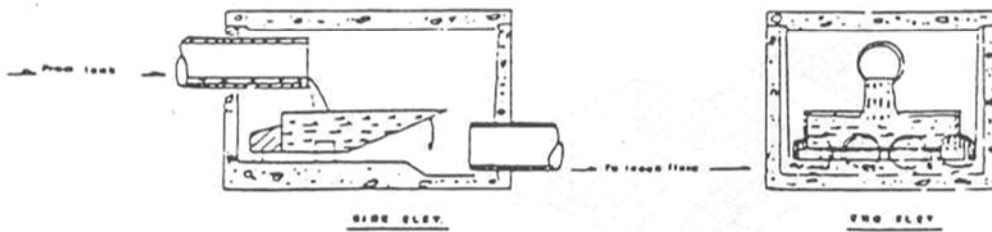
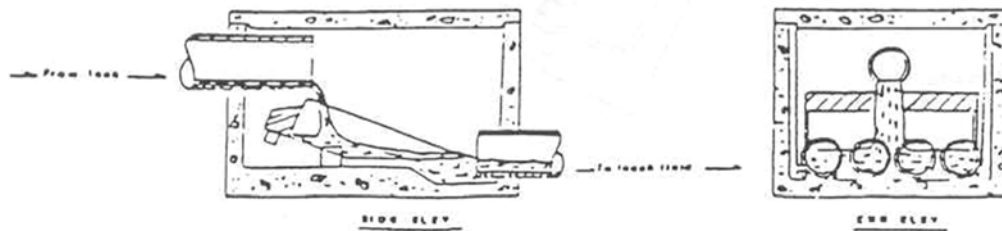
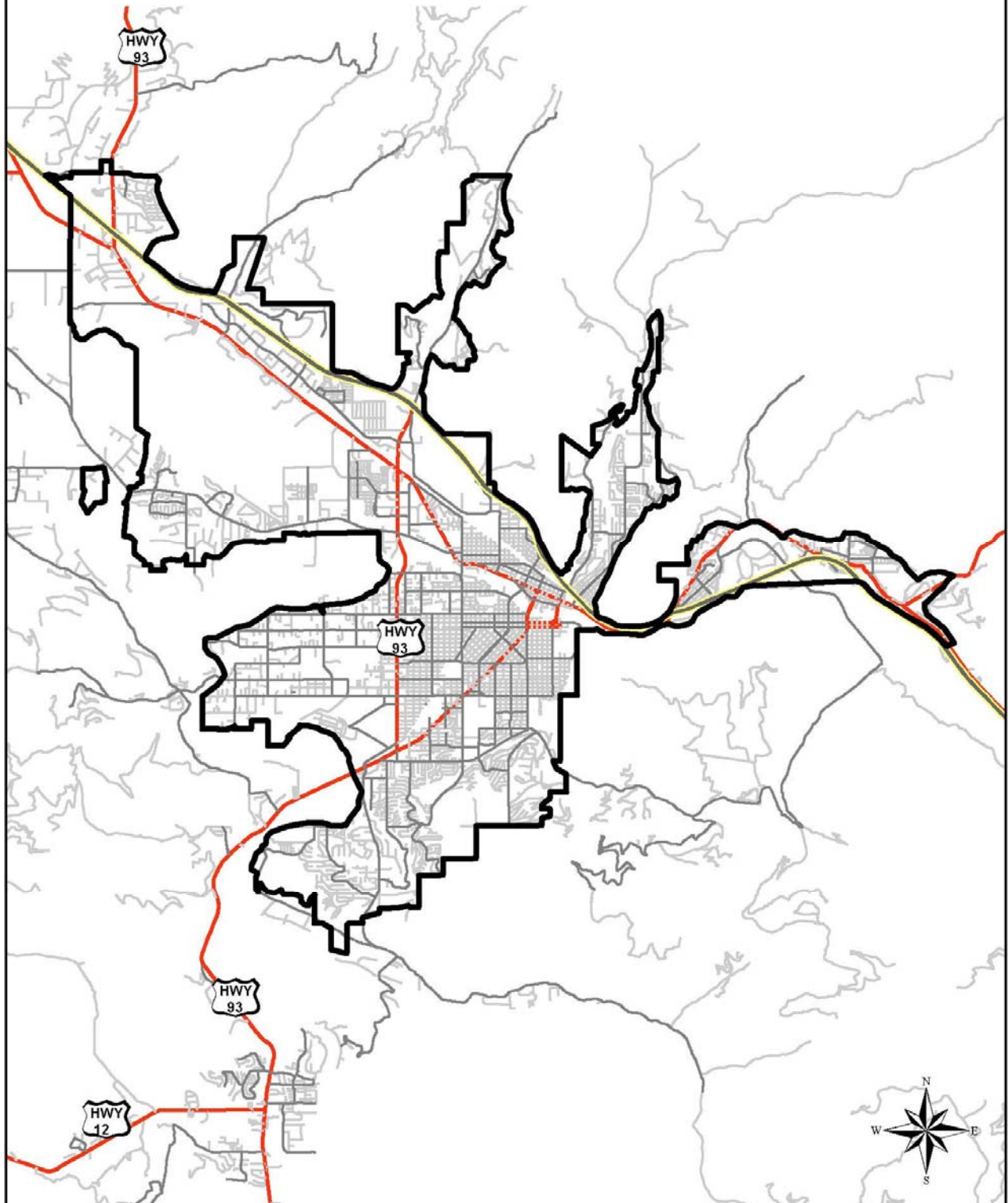

FIG. 4 "DIPPER" drops forward, discharging 1.7 gallons in 1-2 seconds into the outlet flow.



## Appendix D Missoula Wastewater Treatment Plant Service Area



Appendix E: Rattlesnake Special Management Area

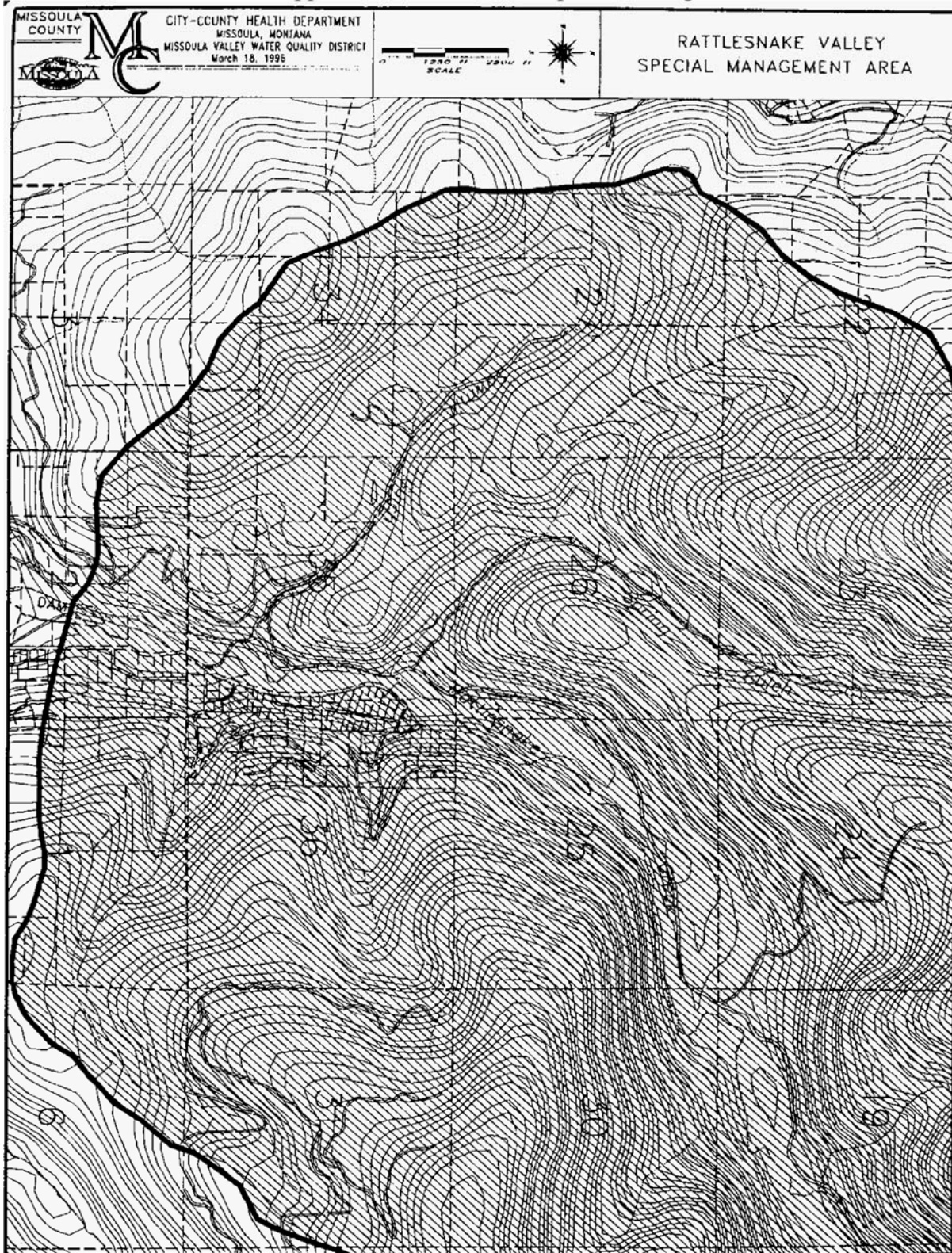

## **Appendix F**

### **Identifying Bedrooms to Determine Wastewater Design Flows**

The following guidelines will be used by the Department to determine how many rooms in a house are to be counted as bedrooms for sizing a wastewater treatment and disposal system.

#### **Current room use**

A room that has been or is currently being used as a sleeping room, even if not constructed to the current building code standards, will be counted as a bedroom. The Department can make exceptions to this requirement if the use is temporary (e.g., weekend house guests sleeping on a pull out couch in the living room or den.)

#### **Unfinished basements**

If the basement will be unfinished at the time of permitting, it will be counted as one additional bedroom. If the basement is later finished, a permit for increased use will be required if the basement is proposed to have more bedrooms than allowed by the current septic permit.

#### **Possible room use**

A room that is not used for sleeping currently, but may be used for sleeping in the future, will be considered a bedroom under the following circumstances:

- It's labeled as a bedroom on the floor plans; or
- It has a minimum floor area of 70 square feet with a window or door to the outside (regardless of whether the egress is legal by building department standards) and it has the expected degree of privacy typical of a bedroom; or
- It's an open loft area that has at least 70 square feet of floor space, and no other rooms access off of it.
- It's a room with downward-tapering ceilings with at least 70 square feet, not counting any areas where the ceiling is less than 5' tall.

A room that is not used for sleeping or labeled a bedroom will not be counted a bedroom under the following circumstances:

- It is obviously a kitchen, bathroom, living room, dining room, laundry room, storage room (with no windows or with ceilings less than 5' tall), utility room or family room
- It has an arched doorway that lacks a door, half walls, or other architectural features that limit privacy or use as a bedroom (such as sloped floors in a home theater).
- It has no egress or source of light to the outside.
- It's used as a passage to other rooms, stairs, or bathrooms unless this is the only sleeping area in the dwelling
- It's not finished living space, such as a storage shed, potting shed, greenhouse or shop.

#### **Buildings not connected to water or septic**

A separate building without plumbing or running water may be considered as one or more additional bedrooms to a structure with plumbing or running water. Examples include a bunk house or artist studio.

## Appendix F(continued)

### Quick Reference Table

The table below is intended to be used as a reference by the Department, when determining whether a room (that's not currently being used for sleeping) should be counted as a bedroom for the purpose of septic system sizing. The department will make a decision based on all available information and a single item (whether an obstacle or support) might not disqualify a room from being counted as a bedroom.

Obstacles to Bedroom Designation	Support for Bedroom Designation
The room is obviously a kitchen, bathroom, living room, dining room, laundry room, storage room (without windows) or family room.	Legal Egress
Large Entryway, no door, half walls, or other features that limit privacy.	Has a Closet
Low Ceilings	Area greater than 70 sf
No source of ventilation or lighting from outside	Currently used as a bedroom
Rooms that are used as a passage to other uses	Defined as bedroom by Assessor or building plans
Open Lofts that lead to other rooms	Rooms Adjacent to Bathroom
Media rooms with sloped floors	On second level and not bathroom
Room with mechanical facilities or laundry plumbing connections	Rooms in accessory buildings without plumbing
Room in separate building that is not finished living space, such as a storage shed or greenhouse	

#### NOTES:

**Expected Privacy:** This term is difficult to define. The maximum level of privacy a room could offer is if it has four walls and a closable door. However, the absence of one of those components does not necessarily limit the expected privacy to a degree in which the room could not be reasonably used as a bedroom. For instance, an expanded entryway such as a wide archway with no door *can* remove a room's ability to offer privacy, but that archway must be located in such a way that the room becomes open to the adjacent portion of the home. Conversely, the same door-less entryway could exist, but could be positioned so that you enter the room and then turn 90 degrees to continue further into the room. Picture a public restroom that has been designed so that there are no doors in the entry. While entering, one makes a series of turns that create a degree of expected privacy. This is why the department looks closely at the details of interior layouts when determining the level of expected privacy, and each case is a little bit different.

**Lofts:** Lofts do not have four walls, but are elevated above the rest of the living space. More often than not, a bed can be tucked away so that it is not visible to those in the living room or kitchen. In addition, the vast majority of lofts we have come across are used as sleeping space. This is especially true in recreational cabins where, although seasonal, use is generally high for short periods and sleeping space is generally limited. All that said, a loft will not be counted as a bedroom if there is a clear reason that it would be unlikely to be used for sleeping. Examples include a loft that serves as an entryway into another room or rooms, or one that has less than 70 square feet.

**Limitation/Disclaimer:** This definition of "bedroom" is only applicable when estimating wastewater flow from a dwelling. It cannot be used to determine the adequacy or safety of a room for sleeping purposes. For adequacy and safety requirements, please contact the applicable Building Department.



Appendix G: Seeley Lake Special Management Area

